

# WHIRLPOOL

A I R C O N D I T I O N E R S



SENSING THE DIFFERENCE



Home  
*comfort*  
solutions

Intelligent  
appliances  
to *make your life*  
more efficient *and*  
pleasurable

# INTRODUCING THE NEW DESIGN SERIES

Adding to the exciting selection of Whirlpool air conditioners, the new Design Series extends the existing range for a complete choice of appealing aesthetics to integrate your home's style. Whirlpool Design Series offers the same impeccable quality and performance as the rest of the range, with additional design features to suit individual needs.

## Innovative ideas for an ideal climate

Cool comfort is achieved through the intelligent control of the following operating functions:



dehumidification



cooling



heating



ventilation

### Functional Excellence Sense the difference

#### Quiet cool

Whirlpool air conditioners ensure a peaceful, quiet home environment whilst efficiently providing cool comfort to the entire household. At lowest fan speed, the noise level of the 8000 Btu model, is lower than that of a latest generation domestic dishwasher.

#### Clean cool

All Whirlpool air conditioners are equipped with a set of 2 different filters. The first one is a pre-filter, specially treated with an anti-bacterial agent, that catches very small dust particles in the air. It can be easily removed and washed. Green range air conditioners and Eco range air conditioners also feature a special Hepa Filter, able to capture tiny 0.3 micron-sized particles and pollen from the air. Hepa filters have a minimum effectiveness of 99.97%, and deodorize the air by eliminating unpleasant odours, ensuring the highest level of health protection in your home.

#### Mighty, uniform cool

Advanced rotary compressors guarantee refrigerant compression with minimal loss, thus significantly enhancing cooling efficiency. All Whirlpool air conditioners' indoor units are equipped with double flaps, which allow uniform airflow for an optimally balanced air conditioning. Air flow direction can be precisely adjusted through the twin flaps using the remote control unit, so that cool or warm air reaches every corner of the room.



# COOL COMFORT

## Compact, efficient design

Whirlpool air conditioners are characterized by a stylish, yet discreet design. The white, compact-sized indoor units blend harmoniously into your home environment, providing the highest level of comfort without being noticed. Outdoor units have been designed for easy handling and to withstand external climate conditions, with plastic covers to protect tubes and prevent oxidation.

## Easy cool

All single-split air conditioners have a stylish, compact remote control unit with easy 6<sup>th</sup> sense, Round U and Jet buttons, and a large liquid crystal display. Function, temperature and airflow can be easily adjusted. For maximum comfort, programmable Timer and Sleep options are also available.

All Whirlpool air-conditioners feature an Auto-restart function, which will allow the unit to automatically re-start, after a power failure or an accidental disconnection, at the last setting before it was disconnected.

The front panel of the indoor unit on all split air conditioners can be easily removed and washed under running water.



## Function

When setting the 6<sup>th</sup> sense function, a temperature sensor in the indoor unit will automatically detect air temperature in the room and decide on the ideal combination of operating functions - cooling, heating, fan only and drying - to achieve maximum comfort.



## Sleep mode function

This function automatically controls airflow speed and selects the ideal pattern of slightly increasing or decreasing temperature, according to whether it is in a cooling or heating function. Such patterns run over a period of 8 hours and have been designed to provide maximum comfort during sleep. A temperature that feels comfortable when we are awake may prove too cold, or warm, once we are fast asleep. The sleep mode intelligent function takes these natural adjustments into account.



## Function

A fast cooling function is available on all split air conditioners. Easily activated by the jet button on the remote control unit, it sets the appliance to operate at high fan speed and cools the room automatically to 18°, regardless of the temperature previously set.

# Pure and clean air

**Besides making your home or business more comfortable Whirlpool air conditioners can also make the air you breath at home or work healthier. By offering the latest in filter technology, Whirlpool air conditioners create the ideal climate in your home for years of comfort and well being.**

## Active Carbon Filters

### Effectively absorbs smoke and dust

Active Carbon Filters work based on the principle of adsorption, which is different from absorption, and is the physical attraction and adherence of gas or liquid (vapour) molecules to the surface of a solid. The large porous surface area of an active carbon filter adsorbs harmful gas and odours from the air as the air is passed through the active carbon and becomes trapped in its pores. The filter can trap particles of pollen, dust, smog, pet dander, tobacco smoke, mildew, and mold spores as small as 0.3 microns. In general, the filter needs to be replaced every four months depending on exposure to contaminants and the use of the unit.

#### Standard on:

**Eco Inverter Range**

**Green Slim Range without LED**

**Green Dual Range without LED**

**Super Tropical Range**

## Electrostatic Filter

### Makes the air fresher

The electrostatic filter is made of polypropylene and polyurethane, which, when air is forced through the filter creates an electrical charge. This charge attracts airborne particles as small as 0.3 microns and traps them in the filter. The filter never requires replacement as it can be cleaned gently with mild soap and water, and then reused.

#### Standard on:

**Green Slim Range with LED display**

**Green Dual Range**

# COOL COMFORT

## Photic Catalyst Filter

### Reduces disease germ and odours

Photocatalyst filter system contains two key components: a UV lamp and a chemically treated filter. Exposure to this ultraviolet light causes the chemicals in the filter to become photoconductive. By means of this chemical process the photocatalyst filter cleans the air of microorganisms including fungus, bacteria spores and airborne viruses. This filter can also decompose odours with a deodorizing ability equal to 500 active-carbon deodorants. Its effect can last for about three to five months depending on the use of the unit.

#### Standard on:

**Eco Single Range**

**Green Slim Range with LED display**

**Green Dual Range with LED display**

**Design Series Single Flat**

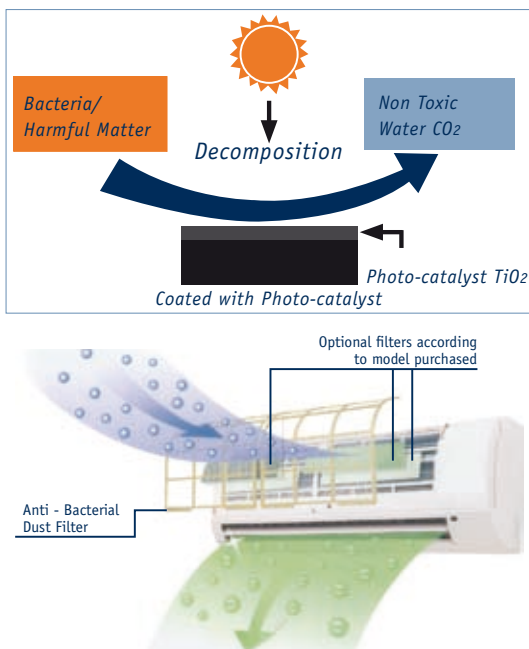

## Anti - Dust Filter.

### Washable and reusable filter to trap dust.

#### Standard on all models except:

**Design Series Slim**

**Window Tropical and Super Tropical Range**

**Super Tropical Range**



## HEPA Filter

### Eliminates pollen, mill dust and pneumobacillus

HEPA means "high efficiency particulate air" and it is constructed of hundreds of small glass fibres that together form a sort of pleated paper through which air can pass; however, as the air passes through the filter small particles 0.3 microns in size become trapped and the air exits clean.

#### Standard on:

**Green Range Single Split**

**Eco Single and Dual Range**

**Classic Range Tropical/Super Tropical Range**

**30K BTU Commercial Split**

**Eco Inverter Range**

## Negative Ion Filter

### Filters and absorbs positive ion

Exposure to negative ions has been scientifically proven to make human beings feel better. In nature, sunlight, lightening, lakes, and ocean waves all generate negative ions. The negative ion filter works by emitting negative ions that cause positively charged particles such as dander, pollen, dust, and mold spores to clump together and fall to the floor where they can be easily removed from the environment. By preventing particles from staying airborne, negative ions help to keep the air clear and pure.

#### Standard on:

**Green Range Single Split**

**Eco Dual Range**

**30K BTU Commercial Split**

**Classic Range Tropical/Super Tropical Range**

## Nano-metre Catalyst Filter

### For a healthy and comfortable space

The catalyst filter filtrates, at the nano-metre level, viruses, bacteria and harmful gases and it purifies dust and peculiar odors making the air in the room fresh and the environment clean and healthy.

#### Standard on:

**Design Series Slim Range**

## Germ-Killing Filter

### Aiming to provide a safe and clean living space

It kills germs efficiently and traps odors at the same time.

#### Standard on:

**Design Series Slim Range**

<b>AIR CONDITIONERS - R407c</b>	8
SINGLE AND DUAL - R407c	11
GREEN SLIM SINGLE AND DUAL RANGE - R407c	12
<b>AIR CONDITIONERS - R410a</b>	13
SINGLE AND DUAL RANGE - R410a	15
ECO INVERTER RANGE - R410a	16
INVERTER SINGLE RANGE- R410a	17
<b>AIR CONDITIONERS - R22</b>	18
TROPICAL AND SUPER TROPICAL RANGE - R22	20
SLIM SINGLE RANGE - R22	21
<b>WINDOW TYPE AIR CONDITIONERS - R22</b>	22
REMOTE CONTROLS	23
<b>PORTABLE UNITS R410a</b>	24
<b>CEILING CASSETTE - R407c</b>	25
<b>FLOOR CEILING - R407c</b>	25
<b>COMMERCIAL SINGLE SPLIT (30K BTU) - R407c/R22</b>	26
TECHNICAL SPECIFICATION	27
UNIVERSAL SPARES & ACCESSORIES	41



# AIR CONDITIONERS R407c

## SINGLE RANGE - R407c



UNIT	MODEL	BTU	ENERGY CLASS (cooling-heating)
	AMC 980	7000	B/B
	AMC 981	9000	B/C
<b>Design Series Slim</b>	AMC 982	12000	C/D
	AMC 983	19000	C/D
	AMC 984	23000	D/D



	AMB 859/G	7000	B/B
	AMB 857/G	9000	B/C
<b>Single Split Green Range</b>	AMB 867/G	12000	C/D
	AMB 877/G	19000	C/D
	AMB 887/G	23000	D/D

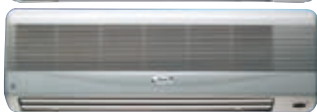

<b>Dual Split Green Range</b>	AMB 891/G	9400x2	C/D
	AMB 892/G	9400+12000	C/D

## GREEN SLIM RANGE - R407c



UNIT	MODEL	BTU	ENERGY CLASS (cooling-heating)
without LED	AMB 960	2000	B/B
	AMB 961	9000	C/C
	AMB 962	12000	C/D
	AMB 963	19000	C/D
<b>Slim Single</b>	AMB 964	23000	D/D
with LED	AMB 966	7000	B/B
	AMB 967	9000	C/C
	AMB 968	12000	C/D
	AMB 969	19000	C/D
	AMB 970	23000	D/D



<b>Slim Dual</b>	without LED	AMB 965	9430+12151	C/D
	with LED	AMB 971	9430+12151	C/D



# AIR CONDITIONERS

## Green Range - Friendly to the environment

### Introducing the Design Series Slim

Whirlpool new Design Series Slim, brings the same impeccable, reliable comfort to your home with an added stylish touch of crisp, elegant design. The horizontal grid pattern is completed by an extended but simplified display area, allowing the split unit to blend elegantly into your home environment.



### Green range single split

Whirlpool Green range air conditioners use the environmental friendly R407c refrigerant gas that does not damage the ozone layer. R407c has a zero impact on the environment, in accordance with Whirlpool directive to be environmentally friendly.



### Slim Green range single split

The slim range single split conditioner discreetly fits into any environment, especially where space restraints are better addressed by a less bulky design with a single flap for air flow direction, it is a smaller format in all aspects, including simplified operation for ease of use and peace of mind.



### Green range dual split

Green range dual split models provide cool comfort in two separate rooms in your home, whilst running on a single outdoor unit. The two indoor units work independently from each other and allow to set different levels of cooling/heating in each room. Like single split models, dual split models in the Green range run on the environmental friendly R407c gas.



### Slim Green range dual split

The dual split version of the slim model allows for the same flexibility of other dual split conditioners. Cool comfort in two separate rooms, with reduced dimensions of the individual units and simplified operation. The units can be set independently from one another. Here again the R407c gas ensures a zero impact on the environment.



### User Friendly Remote control

It features a backlit liquid crystal display (not available on the Design Series), a real time clock and a key lock that prevents the buttons from being pushed accidentally.

# COOL COMFORT

With compact aesthetics the slim split range is appealing and user friendly. In fact with the new led display you can comfortably read the temperature in the room while sitting on the sofa and you can also check the mode of your air conditioner.

## Operating and Display



SLIM model without LED



SLIM model with LED

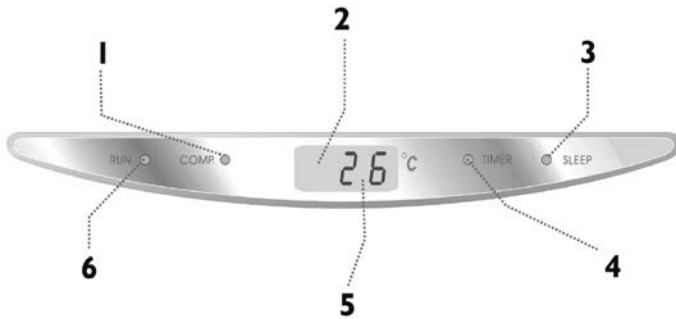

### 1. Compressor Indicator (Red)

It lights up when compressor is running.

### 2. Signal receptor

Receives signal from the remote control.

### 3. Sleep indicator (Yellow)

It lights up when the unit is in sleep mode.

### 4. Timer Indicator (Orange)

It lights up during the set time.

### 5. LED display

Displays set temperature when setting temperature or it displays room temperature.

### 6. Run Indicator (Green)

It is on during operation.

## Choosing the right air conditioner

It is important that the unit you choose is the correct size for the space that it will be required to cool. If the size is too big the air conditioner will continuously be shutting on and off as it will cool the room too quickly; conversely if the unit size is too small it will run continuously without properly cooling the room. This will use up a lot of energy meaning higher than necessary electric bills. In addition the air conditioner will not be able to dehumidify the air in the room effectively leaving it cold and clammy. For these reasons we suggest having the correct measurements on hand for choosing the right air conditioner. Simply follow the below instruction for ease of reference :

1. Measure the room. (Length x Width = area in square meter)
2. Match the room size to BTUs. See chart below

Kw/hr	BTU/H	Area to be cooled (Sq meter)
2,1	7000	23 a 28
2,6	9000	28 a 37
3,5	12000	37 a 51
5,3	18000	51 a 92
6,4	22000	92 a 120
7,0	24000	120 a 139
8,8	30000	139 a 185
12,0	41000	370
2,6+2,6	9000+9000	28 a 37 x 2
2,6+3,5	9000+12000	28 a 37 + 51 a 92

### Adjust your BTU size for the following circumstances :

1. If the room is heavily shaded, reduce capacity by 10%
2. If the room is very sunny, increase capacity by 10 %
3. If more than two people regularly occupy the room, add 600 BTUs for each additional person.
4. If the unit is used in a kitchen, increase capacity by 4000 BTUs.

We always recommend that you consult a Whirlpool professional installer before you purchase the product.

## DESIGN SERIES SLIM

**AMC 980**  
**AMC 981**  
**AMC 982**

**AMC 983**  
**AMC 984**

**R407c**



## GREEN DUAL RANGE

**AMB 891/G**  
**AMB 892/G**



## GREEN SINGLE RANGE

**AMB 859/G**  
**AMB 867/G**  
**AMB 887/G**

**AMB 857/G**  
**AMB 877/G**



- Stylish and compact design
- 6th sense remote control
- Green, environment friendly refrigerant R407c
- Real time clock on remote control
- Key Lock on remote control
- Special functions: 6th sense Jet
- Special functions: Cooling Heating Dehumidification Ventilation (Fan only)
- 24h timer
- Sleep operation mode for the night
- Swing button to set vertical airflow control
- 3 fan speeds + auto
- Auto-restart
- Washable anti bacterial dust filter (Green Range only)
- HEPA filter and IONISER filter (Green Range only)
- Nano-metre Catalyst Filter Germ-Killing Filter (Design Series only)
- Washable indoor panel
- Twin flaps operated by remote control
- Twin or single flap according to Design Series model
- Wide angle air swing
- Wide angle air swing (90° o 80° Design Series)
- High efficiency rotary compressor

### OUTDOOR UNITS



- Stylish and compact design
- 6th sense remote control
- Green, environment friendly refrigerant R407c
- Real time clock on remote control
- Key Lock on remote control
- Special functions: 6th sense Jet
- Special functions: Cooling Heating Dehumidification Ventilation (Fan only)
- 24h timer
- Sleep operation mode for the night
- Swing button to set vertical airflow control
- 3 fan speeds + auto
- Auto-restart
- Washable anti bacterial dust filter
- ELECTROSTATIC filter and PHOTIC CATALYST filter
- Washable indoor panel
- Twin flaps operated by remote control
- Wide angle air swing
- High efficiency rotary compressor
- Compact outdoor unit

### OUTDOOR UNIT



## GREEN SLIM SINGLE RANGE

## DUAL RANGE

Model without LED

**AMB 960**  
**AMB 961**  
**AMB 962**  
**AMB 963**  
**AMB 964**

Model with LED

**AMB 966**  
**AMB 967**  
**AMB 968**  
**AMB 969**  
**AMB 970**

**R407c**

Model without LED

**AMB 965**

Model with LED

**AMB 971**



- Compact design
- 6th sense remote control
- Green, environment friendly refrigerant R407c
- Special functions: 6th sense  
Jet
- Special functions: Cooling  
Heating  
Dehumidification  
Ventilation (Fan only)
- 24h timer
- Sleep operation mode for the night
- Swing button to set vertical airflow control
- 3 fan speeds + auto
- Auto-restart
- Washable anti-bacterial dust filter
- ACTIVE CARBON filter for model without LED
- ELECTROSTATIC filter and PHOTIC CATALYST filter for model with LED
- Washable indoor panel
- Automatic air swing
- High efficiency rotary compressor

OUTDOOR UNIT



- Compact design
- 6th sense remote control
- Green, environment friendly refrigerant R407c
- Special functions: 6th sense  
Jet
- Special functions: Cooling  
Heating  
Dehumidification  
Ventilation (Fan only)
- 24h timer
- Sleep operation mode for the night
- Swing button to set vertical airflow control
- 3 fan speeds + auto
- Auto-restart
- Washable anti-bacterial dust filter
- ACTIVE CARBON filter for model without LED
- ELECTROSTATIC filter and PHOTIC CATALYST filter for model with LED
- Washable indoor panel
- Automatic air swing
- High efficiency rotary compressor

OUTDOOR UNIT



# AIR CONDITIONERS R410a

## DESIGN SERIES AND ECO RANGE - R410a



UNIT	MODEL	BTU	ENERGY CLASS (cooling-heating)
	AMC 990	7000	A/A
	AMC 991	9000	A/A
<b>Single Range</b>	AMC 992	12000	A/B
<b>Design Series Flat</b>	AMC 993	19000	B/A
	AMC 994	24000	B/C
<b>Dual Range</b>	AMD 060	9100x2	A/C
<b>Design Series Flat</b>	AMD 061	9100+12000	B/C



	AMB 951	7000	A/A
	AMB 953	9000	A/A
<b>Eco Range Single</b>	AMB 955	12000	A/B
	AMB 957	18000	B/C
	AMB 959	23000	B/C



<b>Eco Range Dual</b>	AMB 972	9400x2	C/C
	AMB 973	9000+12000	C/C

## INVERTER RANGE - R410a



UNIT	MODEL	BTU	ENERGY CLASS (cooling-heating)
<b>Inverter - Design Series Flat</b>	AMC 996	9000	A/A
	AMC 998	12000	A/B



<b>Eco Inverter Range</b>	AMB 869/G	9000	A/A
	AMB 868/G	12000	A/B

# AIR CONDITIONERS - R410a

## The Design Series and Eco Product Range Greener cool: Environmental friendly and efficient

### Introducing the Design Series Flat

The Design Series, another addition to Whirlpool's current product range, provides an even greater variety of design options to find that perfect match with your home environment. The Design Series range, Flat models include versions equipped with the highly advanced **inverter technology**, and it's also available as a **Dual Range**.



### Eco range single split

The conditioners in the Whirlpool ECO range are equipped with the R410a refrigerant gas. Aside from not damaging ozone layer and free of any substances harmful to the environment, R410a makes the operation of the air conditioners in the ECO range significantly more energy efficient. Appliances using R410a gas achieve a higher classification in terms of energy efficiency, e.g. the ECO range Split models 7000 and 9000 BTU are class "A" products. In other words, it takes less energy to achieve the same level of comfort, which results in an even higher standard in environmental awareness. The R410a gas also gives the ECO range appliances more power and speed to give you the ideal climate in your home.

### Eco DC Inverter range single split

Whirlpool's ECO range features a highly advanced INVERTER model. Inverter technology precisely controls compressor rotation speed; when the room warms up, the compressor speed increases proportionately; when the room cools down, the compressor slows down. This means that the compressor wattage and the amount of refrigerant used at a certain time, vary depending on the actual ambient temperature. This reduces energy consumption and hence costs, whilst maintaining your home's temperature at the highest possible comfort level. As a unique feature, Whirlpool's ECO INVERTER utilises Direct Current (DC) whilst running on your home's AC mains. This provides for a further increase in terms of cooling/heating power.



### Eco range dual split

Whirlpool Eco range also features dual split models to provide cool comfort in two separate rooms.



### Function

The Round U advanced function, available on the Design Series and ECO range air conditioners, has the further advantage of having an advanced sensor lodged in the user friendly remote control unit, thus keeping the central unit updated with more accurate info about the cooling/heating requirements in the actual vicinity of the user every 10 minutes.

### User friendly Remote Control

The eco range conditioners have a user-friendly designed, compact remote control. It features a backlight liquid crystal display, a real time clock and the advanced Round U function.

## DESIGN SERIES FLAT

AMC 990  
AMC 991  
AMC 992

AMC 993  
AMC 994

R410a

## DUAL RANGE

AMD 060  
AMD 061



## ECO RANGE SINGLE

AMB 951  
AMB 955  
AMB 959

AMB 953  
AMB 957



## ECO RANGE DUAL

AMB 972

AMB 973



- Stylish and compact design
- Round U remote control with backlight display
- Green, environment friendly refrigerant R410a
- Real time clock on remote control
- Special functions:
  - 6th sense
  - Round U
  - Jet
- Special functions:
  - Cooling
  - Heating
  - Dehumidification
  - Ventilation (Fan only)
- 24h timer
- Sleep operation mode for the night
- Swing button to set vertical airflow control
- 3 fan speeds + auto
- Auto-restart
- Washable anti-bacterial dust filter
- HEPA filter (optional on Design Series)
- PHOTIC CATALYST filter
- Washable indoor panel
- Twin flaps on indoor unit
- Wide angle air swing
- High efficiency rotary compressor

- Stylish and compact design
- 6th sense remote control with backlight display
- Green, environment friendly refrigerant R410a
- Real time clock on remote control
- Special functions:
  - 6th sense
  - Round U
  - Jet
- Special functions:
  - Cooling
  - Heating
  - Dehumidification
  - Ventilation (Fan only)
- 24h timer
- Sleep operation mode for the night
- Swing button to set vertical airflow control
- 3 fan speeds + auto
- 4 Fan speeds + auto
- Auto-restart (set and cannot be modified)
- Washable anti-bacterial dust filter
- Photic Catalyst filter
- HEPA filter (optional on Design Series)
- HEPA filter and IONISER filter
- Washable indoor panel
- Twin flaps on indoor unit
- Wide angle air swing
- High efficiency rotary compressor

OUTDOOR UNITS



OUTDOOR UNITS



# ECO INVERTER RANGE - R410a



## Inverter technology is providing quick and comfortable cooling whilst saving energy

### Turbo cool

The Eco Inverter features a Turbo function, similar to the jet function of other models, but with an increased fan speed and thus quicker cooling or heating of the room. The set temperature in cooling mode is 18°, while in the heating mode it is 32°C. To exit TURBO mode press the TURBO button again.

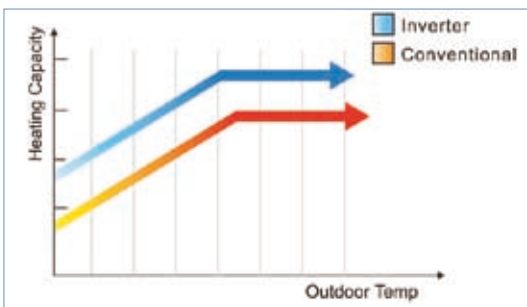

### Faster

Selected temperature is reached faster than with conventional air conditioners. The high frequency operation at start-up increases cooling/heating capacity by 30% to 50%, hence reaching set temperature twice as fast.

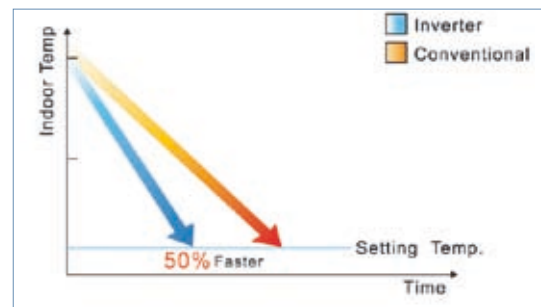

### Ever more energy efficient

Inverter technology controls the electrical frequency of the compressor according to the cooling and heating load of a room. When less power is needed, frequency is lowered, therefore reducing electricity consumption. The savings in energy consumption can be as high as 30% when compared to conventional technology.

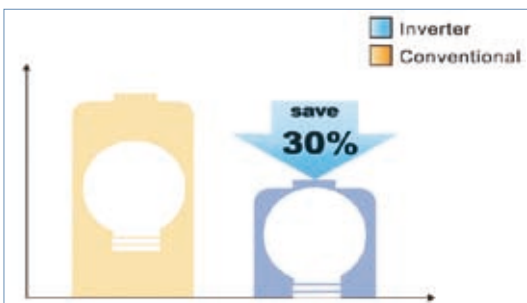

### More precise, more comfortable

The Inverter's unique frequency conversion technology ensures that deviations from the set temperature are minimized without having to frequently switch the unit on and off. The room temperature fluctuation is kept within a minimal +/- 0,5°C range, which adds to the high standard of comfort.

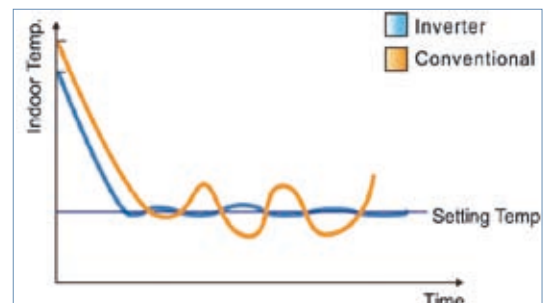



# INVERTER RANGE

R410a

## DESIGN SERIES FLAT

AMC 996  
AMC 998



## ECO INVERTER RANGE

AMB 869/G  
AMB 868/G

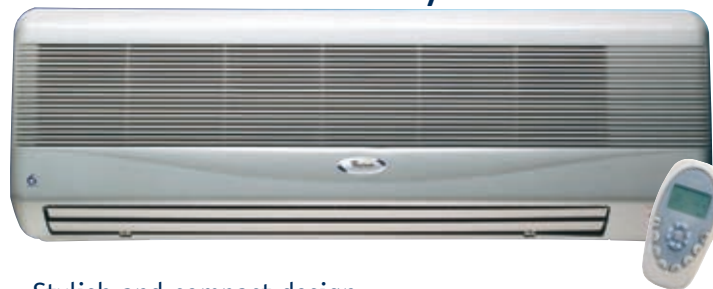

- Stylish and compact design
- 6th sense remote control
- Green, environment friendly refrigerant R410a
- Real time clock on remote control
- Special functions:
  - 6th sense
  - Round U
  - Turbo
- Special functions:
  - Cooling
  - Heating
  - Dehumidification
  - Ventilation (Fan only)
- 24h timer
- Sleep operation mode for the night
- Swing button to set vertical airflow control
- 4 Fan speeds + auto
- Auto-restart (set and cannot be modified)
- Washable anti-bacterial dust filter
- HEPA filter (not available on Design Series)
- ACTIVE CARBON filter (not available on Design Series)
- Washable indoor panel
- Twin flaps on indoor unit
- Wide angle air swing
- High efficiency rotary compressor
- High efficiency scroll compressor (on Design Series only)
- Heating belt on outdoor unit to work down to -15°/-20°C included (on Design Series only)

### OUTDOOR UNITS



# AIR CONDITIONERS R22

## CLASSIC RANGE - R22



UNIT	MODEL	BTU	ENERGY CLASS (cooling-heating)
<b>Design Series Slim</b>	AMC 985	7000	C/C
	AMC 986	9000	D/D
	AMC 987	12000	D/D
	AMC 988	19000	D/E
	AMC 989	22000	E/E



<b>Classic Tropical Range</b>	AMB 859	7000	C/D
	AMB 857	9000	C/C
	AMB 867	12000	D/D
	AMB 877	19000	E/F
	AMB 887	22000	F/F



<b>Classic Super Tropical Range</b>	AMB 873	18000/15140	N/A
	AMB 893	24000/17900	N/A



<b>Slim Single Range</b>	AMB 854	9000	D/D
	AMB 864	12000	E/E



<b>Window Tropical Range</b>	AMB 758	8600	N/A
------------------------------	---------	------	-----



<b>Window Super Tropical Range</b>	AMB 796	18000/13000	N/A
------------------------------------	---------	-------------	-----

# AIR CONDITIONERS - R22

## Design Series and Classic Range

### Design Series Tropical Slim Range

Even in extreme climate conditions, Whirlpool's range of air conditioners offers the widest possible choice of exciting design to bring stylish comfort to your home. The new Tropical Design Series, combines high efficiency with simplicity of design to better suit individual needs.



### Tropical and Super Tropical range single split

Whirlpool classic range of air conditioners is designed for easy installation in your home reaching the best results of cool comfort. The simplicity of their design makes them compatible with any interior design solution.

Whirlpool range of products also features tropicalized models which can withstand temperature up to 52°C.

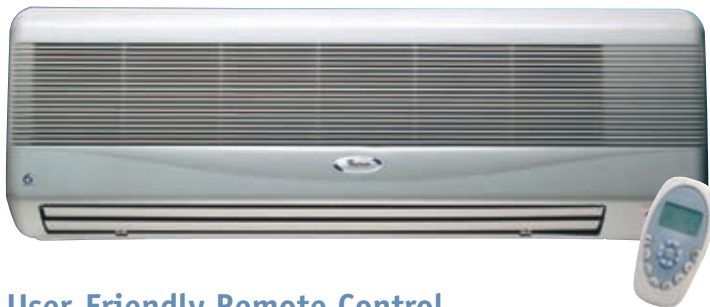

### Slim range single split

The slim range single split air conditioners discreetly fits into any environment, especially where space restraints are better addressed by a less bulky design with a single flap for air flow direction, it is a smaller format in all aspects, including simplified operation for ease of use and peace of mind.



### User-Friendly Remote Control

The classic range air conditioners have a user-friendly, compact remote control. It features a backlit liquid crystal display (not available on the Design Series), a real time clock and a key lock that prevents the buttons from being pushed accidentally.



## TROPICAL RANGE

## SUPER TROPICAL RANGE

### DESIGN SERIES SLIM

**AMC 985**  
**AMC 986**  
**AMC 987**

**AMC 988**  
**AMC 989**

**R22**

**AMB 873**  
**AMB 893**



### CLASSIC TROPICAL RANGE

**AMB 859**  
**AMB 867**  
**AMB 887**

**AMB 857**  
**AMB 877**

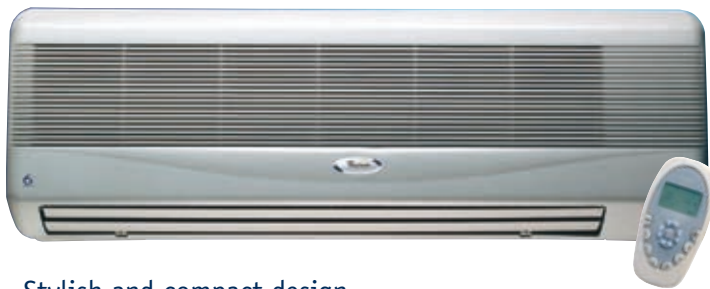

- Stylish and compact design
- 6th sense remote control
- Green, environment friendly refrigerant R407c
- Real time clock on remote control
- Key Lock on remote control (not available on Design Series)
- Special functions:
  - 6th sense
  - Jet
- Normal functions:
  - Cooling
  - Heating
  - Dehumidification
  - Ventilation (Fan only)
- 24h timer
- Sleep operation mode for the night
- Swing button to set vertical airflow control
- 3 fan speeds + auto
- Auto-restart
- Washable anti bacterial dust filter (Classic Range only)
- HEPA filter and IONISER filter (not available on Design Series)
- Nano-metre Catalyst Filter  
Germ-Killing Filter (Design Series only)
- Washable indoor panel (optional un Design Series)
- Twin flaps operated by remote control (on AMC 988/989 only)
- Wide angle air swing (90°/80° on Design Series)
- High efficiency rotary compressor

#### OUTDOOR UNITS



- Stylish and compact design
- 6th sense remote control
- Green, environment friendly refrigerant R407c
- Real time clock on remote control
- Key Lock on remote control
- Special functions:
  - 6th sense
  - Jet
- Normal functions:
  - Cooling
  - Heating
  - Dehumidification
  - Ventilation (Fan only)
- 24h timer
- Sleep operation mode for the night
- Swing button to set vertical airflow control
- 3 fan speeds + auto
- Auto-restart
- ACTIVE CARBON filter
- HEPA filter and IONISER filter
- Washable indoor panel
- Twin flaps operated by remote control
- Wide angle air swing
- High efficiency rotary compressor
- Compact new outdoor unit

#### OUTDOOR UNIT



R22

## SLIM SINGLE RANGE

**AMB 854**  
**AMB 864**



- Compact design
- 6th sense remote control
- Green, environment friendly refrigerant R407c
- Special functions: 6th sense  
Jet
- Special functions: Cooling  
Heating  
Dehumidification  
Ventilation (Fan only)
- 24h timer
- Sleep operation mode for the night
- Swing button to set vertical airflow control
- 3 fan speeds + auto
- Auto-restart
- Washable anti-bacterial dust filter
- ACTIVE CARBON filter
- Washable indoor panel
- Automatic air swing
- High efficiency rotary compressor

### ALSO AVAILABLE:

- AMB 853** - cool only
  - 9000 BTU capacity
- AMB 863** - cool only
  - 12000 BTU capacity

OUTDOOR UNIT



**ELECTRONIC**

**AMB 758**



**R22**

**MECHANICAL SUPER TROPICAL**

**AMB 796**



- 8600 and 11500 BTU capacity
- 6th sense remote control
- Special functions: 6th sense  
Jet
- Normal functions: Cooling  
Heating  
Dehumidification  
Ventilation (Fan only)
- 24h timer setting possibility for convenience
- Sleep operation mode for the night
- Swing button to set vertical airflow control
- 3 fan speeds
- Fresh air purification (exhaust)
- Washable indoor panel
- Wide angle air swing
- High efficiency rotary compressor

**ALSO AVAILABLE:**

- AMB 768** - cool only
- 11500 BTU capacity

- 18000 and 24000 BTU capacity
- Normal functions: Cooling  
Dehumidification  
Ventilation (Fan only)
- Swing button to set vertical airflow control
- 3 fan speeds
- Fresh air purification (exhaust)
- Washable indoor panel
- Wide angle air swing
- High efficiency rotary compressor

**ALSO AVAILABLE:**

- AMB 798** - cool only
- 24000 BTU capacity

**WINDOW range**

Whirlpool window air conditioners are self contained units designed to fit into a standard window that slides up or down. Easy to install as all you need is an electric plug and a window to slide the unit into.

Whirlpool range features a number of electronic models equipped of a 6th sense remote control for easy operation as well as a tropicalized range of mechanical models to withstand temperature up to 52°C.

It is advisable to remove your window air conditioner during winter to save on heating costs.

# REMOTE CONTROLS

**THE REMOTE CONTROLS NEED TO BE PRESET AT FIRST USE. PRESETTING MUST BE DONE WITHIN 12 SECONDS, OR IT WILL AUTOMATICALLY BE SET TO THE HEAT PUMP FUNCTIONS**



R407c - R22 Design Series Range

- JET button: Used to activate rapid cooling
- 6TH SENSE button: Used to enter fuzzy logic smart operation
- MODE button: Press this button to change the operation mode in the order of Cool - Dry - Heat - Fan
- SLEEP button: Used to set or cancel Sleep Mode operation
- ROUND U: This function allows the air conditioner to work according to the ambient temperature



R410a Design Series Range

**Remote controls work up to a max distance of 6m from indoor unit**

**MODE:** cooling, dry, fan only, heating

**FAN:** auto, high, medium, low

Dry mode - only set as low

Fan only - hi-med-low

**SWING:** automatic vertical airflow direction control sets as

Cooling, dry - horizontal

Heating, fan only - downward

**TIP:** in cooling, drying modes avoid keeping swing control downwards for too long to prevent condensed water from dripping

**TIMER:** programmable switch on/off timer

not set at day time but as time frame

Before using the air conditioner, be sure to check and preset your remote control. Please refer to the Instruction for Use for further details.

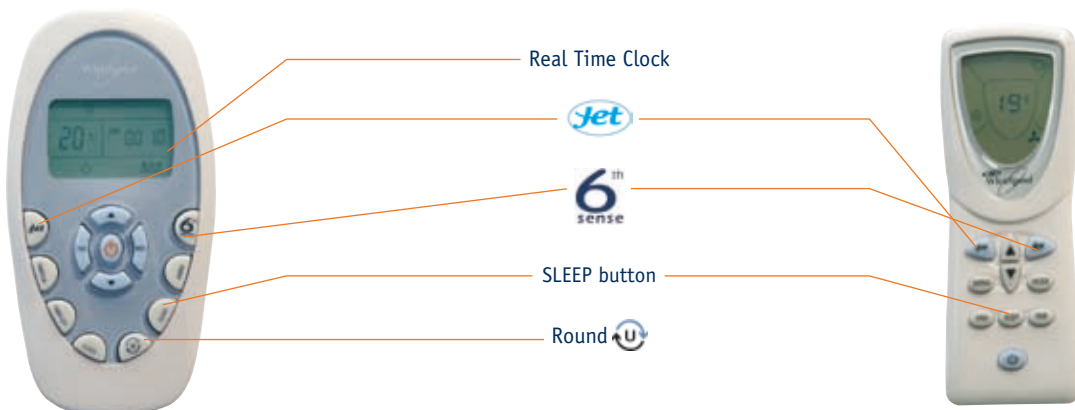

*Remote control type and button functions depend on the air conditioner model purchased*

# PORTABLES

## Friendly to the environment

R410a

### Portable Units

With Whirlpool portable units, cool comfort can now be obtained in any room in your home, at any moment. The small, highly flexible units are optimized single ducting units developed from dual ducting technology for optimal cooling efficiency. The absence of a water tank – a pump drains the condensed water instead – makes operation of the unit easy and carefree. Whirlpool portable cooling units are also equipped with a remote control and the latest 6th sense technology, for the perfect regulation of the temperature in your home. Your portable units are equipped with an installation kit. The kit for installation to the window has been designed to fit most standard vertical and horizontal window applications.

**AMD 096 Silver**



**AMD 097 Blue**



**AMC 995**



■ Including heating elements

## How to Install Your Portable Room Air Conditioner

### Choose a Location:

- Place the portable air conditioner on strong, level flooring near a venting source, such as a window or door
- Allow 49,5 cm to 179 cm of space between the unit and a door or window
- Keep a required 49,5 cm distance between the back air inlet and the wall or other obstacles

NOTE: Do not block air outlet  
Do not use plug adapters or extension cords with this air conditioner

#### Flexible Exhaust Hose

Twist exhaust hose clockwise into the exhaust outlet on the back of the air conditioner

#### Window Exhaust Adapter

Attach window exhaust adapter to flexible exhaust hose; turn clockwise until securely locked into place

#### Adjustable Window Slider

Place slider in window and extend to fit the width; close window and insert window exhaust adapter into slider kit (with flexible exhaust hose connected)

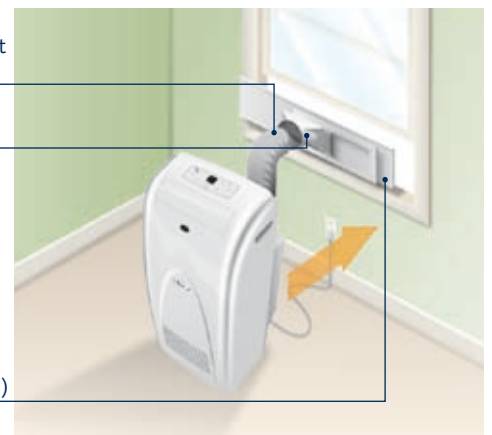



## R407c

### Ceiling Cassette

Whirlpool ceiling cassette conditioners, with their high cooling and heating capacity, are ideal for larger spaces such as commercial premises, restaurants, bars, cafe's or offices. Their ultra slim design fits anywhere and allows for easy installation. Advanced features such as the 6th sense function, a 24 hour ON/OFF timer, easy to use LCD remote control, and 3 speed control make for exceptional performance and comfort. Both models run on the environmental friendly R407C gas.

### AMB 888/G AMB 889/G



- Remote control
- Green, environment friendly refrigerant R407c
- Special functions:
  - 6th sense
  - Round U
  - Jet
- Normal functions:
  - Cooling
  - Heating
  - Dehumidification
  - Ventilation (Fan only)
- 24h timer
- Sleep operation mode for the night
- Swing button to set vertical airflow control
- 3 Fan speeds + auto
- Washable anti-bacterial dust filter
- Washable indoor panel
- Wide angle air swing
- High efficiency rotary compressor for model 888/G
- Scroll compressor for model 889/G

### Floor ceiling unit

Year after year Whirlpool is enlarging the range for commercial applications. The floor ceiling air conditioner make installation easier by easily blending in with your interior design solution. In fact the indoor unit can be installed vertically as a floor console type or horizontally on the ceiling.

### AMB 974



- Remote control
- Green, environment friendly refrigerant R407c
- Special functions:
  - 6th sense
  - Round U
  - Jet
- Normal functions:
  - Cooling
  - Heating
  - Dehumidification
  - Ventilation (Fan only)
- 24h timer
- Sleep operation mode for the night
- Swing button to set vertical airflow control
- 3 Fan speeds + auto
- Washable anti-bacterial dust filter
- Washable indoor panel
- Wide angle air swing

### INSTALLATION DIAGRAM FOR CEILING CASSETTE

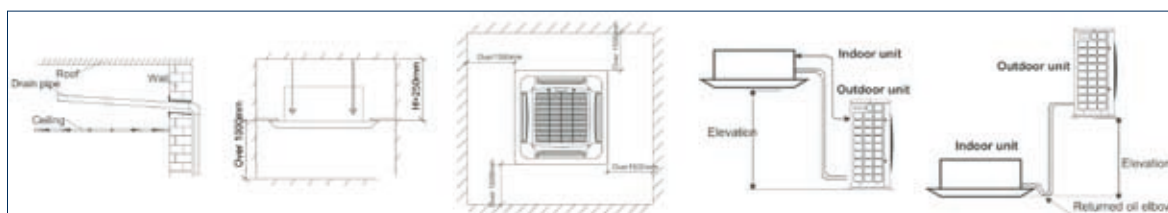

# COMMERCIAL SINGLE SPLIT 30000 BTU

R407c AMB 878

AMB 879

R22



## Commercial single split 30K BTU

With its high cooling capacity of 30000 BTU this unit is specifically suggested for commercial installation. It combines the ease of installation of a single split unit with the high cooling capacity of a professional air conditioner. The model run on the environmental friendly R407c gas. A model is also available on R22 gas for non EU countries.

- Compact design
- 6th sense remote control
- Green, environment friendly refrigerant R407c (on AMB 878)
- Special functions: 6th sense  
Jet
- Special functions: Cooling  
Heating  
Dehumidification  
Ventilation (Fan only)
- 24h timer
- Sleep operation mode for the night
- Swing button to set vertical airflow control
- 3 fan speeds + auto
- Auto-restart
- Washable anti-bacterial dust filter
- HEPA filter
- IONIZER filter
- Washable indoor panel
- Automatic air swing
- High efficiency rotary compressor

OUTDOOR UNIT



# TECHNICAL SPECIFICATIONS



# TECHNICAL SPECIFICATIONS R407c

R407c	DESIGN SERIES SINGLE SLIM				
Model number	AMC 980	AMC 981	AMC 982	AMC 983	AMC 984
12 NC	8528 980 10000	8528 981 10000	8528 982 10000	8528 983 10000	8528 984 10000
EAN Code	80 03437 77476 8	80 03437 77477 5	80 03437 77478 2	80 03437 77479 9	80 03437 77480 5
<b>MAIN FEATURES</b>					
Air conditioner type	Design Series Slim	Design Series Slim	Design Series Slim	Design Series Slim	Design Series Slim
	Heat/Cool	Heat/Cool	Heat/Cool	Heat/Cool	Heat/Cool
Colour (indoor/outdoor)	Global White/Almond White	Global White/Almond White	Global White/Almond White	Global White/Almond White	Global White/Almond White
<b>PERFORMANCES</b>					
Cooling capacity - BTU/h	7400	9200	12100	18000	22700
Cooling capacity - Watt	2169	2696	3546	5275	6653
Heating capacity - BTU/h	8300	9800	14000	19000	25400
Heating capacity - Watt	2433	2872	4103	5569	7444
EER cooling (Btu/watt hr)	10,54	10,27	9,67	9,59	8,91
COP for Heating (w/w)	3,4	3,27	2,96	2,81	2,83
Energy Class (cooling/heating)	B/B	B/C	C/D	C/D	D/D
Noise level - Indoor Unit (dBA) - max	34	35	39	43	53
Noise level - Indoor Unit (dBA) - min	30	30	33	39	43
Noise level - Outdoor Unit (dBA)	48	50	51	54	57
Dehumidification - Liters/h	0,9	0,9	1,4	1,8	2
Air Flow - max (CFM)	190	270	300	530	710
Refrigerant type	R407c	R407c	R407c	R407c	R407c
Refrigerant charge volume (kg)	0,73	0,85	1	1,7	2,2
Climate Class	T1	T1	T1	T1	T1
<b>FEATURES</b>					
6th Sense	Yes	Yes	Yes	Yes	Yes
TURBO cool (Jet)	Yes/Jet	Yes/Jet	Yes/Jet	Yes/Jet	Yes/Jet
Timer on-off 24h	Yes	Yes	Yes	Yes	Yes
Temperature display on remote control	Yes	Yes	Yes	Yes	Yes
Real Time Clock on remote control	Yes	Yes	Yes	Yes	Yes
Key lock on remote control	No	No	No	No	No
Sleep Mode	Yes	Yes	Yes	Yes	Yes
Automatic air swing	Yes	Yes	Yes	Yes	Yes
Fan Only	Yes	Yes	Yes	Yes	Yes
No. of cooling/heating speeds	4 (3 Speeds + Auto)	4 (3 Speeds + Auto)	4 (3 Speeds + Auto)	4 (3 Speeds + Auto)	4 (3 Speeds + Auto)
Twin Flaps	No	No	No	Yes	Yes
Wide angle air swing	90	90	90	90	80
Auto restart after blackout	Yes ( by default setting)	Yes ( by default setting)	Yes ( by default setting)	Yes ( by default setting)	Yes ( by default setting)
Auto Defrost for outdoor unit	Yes	Yes	Yes	Yes	Yes
Removable, washable Panel	Yes	Yes	Yes	Yes	Yes
Compressor type	Rotary	Rotary	Rotary	Rotary	Rotary
<b>CONTROLS</b>					
Remote Control	Yes	Yes	Yes	Yes	Yes
<b>AIR PURIFICATION</b>					
NANO-metre catalyst filter	Yes	Yes	Yes	Yes	Yes
Germ-killing filter	Yes	Yes	Yes	Yes	Yes
HEPA filter	No	No	No	No	No
PHOTIC CATALYST filter	No	No	No	No	No
ION filter	No	No	No	No	No
<b>ELECTRICAL RATINGS</b>					
Volts/Frequency (Hz)	220-240V/50Hz	220-240V/50Hz	220-240V/50Hz	220-240V/50Hz	220-240V/50Hz
Fuse Size (Amps)	20	20	20	25	32
Ampere (A) - cooling	3,2	4,1	5,7	8,4	11,8
Power input (W) - cooling	726	925	1290	1940	2640
Ampere (A) - heating	3,3	4,0	6,4	9	12,2
Power input (W) - heating	737	908	1430	2045	2750
LRA (Lock Rotor Amps)	15	22	31	45	53
Power Cord Length (m) - Cabinet to Wall	1,5	1,5	1,5	1,7	2,5
<b>DIMENSIONS</b>					
Indoor Unit (WidthxHeightxDepth) (mm)	800x290x185	800x290x185	800x290x185	920x295x220	1080x330x230
Indoor Unit 2 (WidthxHeightxDepth) (mm)	No	No	No	No	No
Outdoor Unit (WidthxHeightxDepth) (mm)	665x500x295	665x500x295	830x500x310	860x690x370	935x790x415
Weight indoor/outdoor (Kg)	10/26	10/27	10/37	13/50	15/70

# TECHNICAL SPECIFICATIONS R407c

R407c	GREEN SINGLE					GREEN DUAL	
Model number	AMB 859/G	AMB 857/G	AMB 867/G	AMB 877/G	AMB 887/G	AMB 891/G	AMB 892/G
12 NC	8528 859 10100	8528 857 10100	8528 867 10100	8528 877 10100	8528 887 10100	8528 891 10000	8528 892 10000
EAN Code	80 03437 74965 0	80 03437 74967 4	80 03437 74968 1	80 03437 74969 8	80 03437 74970 4	80 03437 74975 9	80 03437 74976 6
<b>MAIN FEATURES</b>							
Air conditioner type	Green series Split Heat / Cool	Green series Split Heat / Cool	Green series Split Heat/Cool	Green series Split Heat / Cool	Green series Split Heat / Cool	Multi Split Green - 2Compr Heat / Cool	Multi Split Green - 2Compr Heat / Cool
Colour (indoor/outdoor)	White / Gray	White / Gray	White / Gray	White / Gray	White / Gray	White / Gray	White / Gray
<b>PERFORMANCES</b>							
Cooling capacity - BTU/h	7865	9533	12788	19080	23315	9400 X 2	9400 + 12000
Cooling capacity - Watt	2305	2794	3748	5592	6833	2760 X 2	2760 + 3550
Heating capacity - BTU/h	8452	10714	14256	21073	25456	9800 X 2	9800 + 13000
Heating capacity - Watt	2477	3140	4178,2	6176	7460	2880 X 2	2880 + 3800
EER cooling (Btu/watt hr)	10,34	10,30	10,20	9,59	9,38	9,55	9,86
COP for Heating (w/w)	3,42	3,3	3,01	3,14	2,9	3,04	3,05
Energy Class (cooling/heating)	B/B	B/C	C/D	C/D	D/D	C/D	C/D
Noise level - Indoor Unit (dBA) - max	35	35	37	42	44	35	35+37
Noise level - Indoor Unit (dBA) - min	27	27	30	38	38	27	27+30
Noise level - Outdoor Unit (dBA)	50	50	52	54	56	57	57
Dehumidification - Liters/h	0,8	0,9	1,5	2,4	2,7	0,9+0,9	0,9+1,5
Air Flow - max (CFM)	250	250	340	470	570	250x2	420+340
Refrigerant type	R407c	R407c	R407c	R407c	R407c	R407c	R407c
Refrigerant charge volume (kg)	0,7	1,12	1,18	2	2,12	1,140+1,140	1,140+1,140
Climate Class	T1	T1	T1	T1	T1	T1	T1
<b>FEATURES</b>							
6th Sense	Yes	Yes	Yes	Yes	Yes	Yes	Yes
TURBO cool (Jet)	Yes/Jet	Yes/Jet	Yes/Jet	Yes/Jet	Yes/Jet	Yes/Jet	Yes/Jet
Timer on-off 24h	Yes	Yes	Yes	Yes	Yes	Yes	Yes
Temperature display on remote control	Yes	Yes	Yes	Yes	Yes	Yes	Yes
Real Time Clock on remote control	Yes	Yes	Yes	Yes	Yes	Yes	Yes
Key lock on remote control	Yes	Yes	Yes	Yes	Yes	No	No
Sleep Mode	Yes	Yes	Yes	Yes	Yes	Yes	Yes
Automatic air swing	Yes	Yes	Yes	Yes	Yes	Yes	Yes
Fan Only	Yes	Yes	Yes	Yes	Yes	Yes	Yes
No. of cooling/heating speeds	4 (3 Speeds + Auto)	4 (3 Speeds + Auto)	4 (3 Speeds + Auto)	4 (3 Speeds + Auto)	4 (3 Speeds + Auto)	4 (3 Speeds + Auto)	4 (3 Speeds + Auto)
Twin Flaps	Yes	Yes	Yes	Yes	Yes	Yes	Yes
Wide angle air swing	120	120	120	120	120	120	120
Auto restart after blackout	Yes ( by default setting)	Yes ( by default setting)	Yes ( by default setting)	Yes ( by default setting)	Yes ( by default setting)	Yes (pre-set)	Yes (pre-set)
Auto Defrost for outdoor unit	Yes	Yes	Yes	Yes	Yes	Yes	Yes
Removable, washable Panel	Yes	Yes	Yes	Yes	Yes	Yes	Yes
Compressor type	Rotary	Rotary	Rotary	Rotary	Rotary	Rotary x 2	Rotary x 2
<b>CONTROLS</b>							
Remote Control	Yes	Yes	Yes	Yes	Yes	Yes	Yes
<b>AIR PURIFICATION</b>							
Anti bacterial dust filter - washable	Yes	Yes	Yes	Yes	Yes	Yes	Yes
Electrostatic filter	No	No	No	No	No	Yes	Yes
HEPA filter	Yes	Yes	Yes	Yes	Yes	No	No
PHOTIC CATALYST filter	No	No	No	No	No	Yes	Yes
ION filter	Yes	Yes	Yes	Yes	Yes	No	No
<b>ELECTRICAL RATINGS</b>							
Volts/Frequency (Hz)	220-240V/50Hz	220-240V/50Hz	220-240V/50Hz	220-240V/50Hz	220-240V/50Hz	220-240V/50Hz	220-240V/50Hz
Fuse Size (Amps)	20	20	20	25	32		
Ampere (A) - cooling	3,6	4,2	5,7	10	12,2	9,6	11
Power input (W) - cooling	761	922	1254	1990	2485	1964	2183
Ampere (A) - heating	3,2	4,4	6,2	9,8	12,6	9,1	10,7
Power input (W) - heating	724	952	1388	1967	2572	1895	2190
LRA (Lock Rotor Amps)	20	21	30	45	53	21+21	21+30
Power Cord Length (m) - Cabinet to Wall	1,5	1,5	1,5	1,5	1,5	1,5	1,5
<b>DIMENSIONS</b>							
Indoor Unit (WidthxHeightxDepth) (mm)	800x270x168	800x270x168	890x270x168	1025x313x203	1025x313x203	800x270x168	800x270x168
Indoor Unit 2 (WidthxHeightxDepth) (mm)	No	No	No	No	No	800x270x168	800x270x168
Outdoor Unit (WidthxHeightxDepth) (mm)	755x530x252	755x530x252	755x530x252	832x702x380	832x702x380	832x702x380	832x702x380
Weight indoor/outdoor (Kg)	8,5/30	9/34	11/38	16/58	16/60	9/9/63	9/11/70

# TECHNICAL SPECIFICATIONS R407c

R407c	GREEN SLIM SINGLE WITHOUT LED					DUAL
Model number	AMB 960	AMB 961	AMB 962	AMB 963	AMB 964	AMB 965
12 NC	8528 960 10000	8528 961 10000	8528 962 10000	8528 963 10000	8528 964 10000	8528 965 10000
EAN Code	80 03437 75466 1	80 03437 75467 8	80 03437 75468 5	80 03437 75469 2	80 03437 75470 8	80 03437 75471 5
<b>MAIN FEATURES</b>						
Air conditioner type	SLIM series Split	SLIM series Split	SLIM series Split	SLIM series Split	SLIM series Split	Multi Split SLIM - 2Compr
	Heat / Cool	Heat / Cool	Heat/Cool	Heat / Cool	Heat / Cool	Heat / Cool
Colour (indoor/outdoor)	White / Gray	White / Gray	White / Gray	White / Gray	White / Gray	White / Gray
<b>PERFORMANCES</b>						
Cooling capacity - BTU/h	7865	9526	12061	19080	23315	9430+12151
Cooling capacity - Watt	2305	2792	3535	5592	6833	2764+3561
Heating capacity - BTU/h	8575	10113	13648	21073	25456	9895+13054
Heating capacity - Watt	2513	2964	4000	6176	7460	2900+3826
EER cooling (Btu/watt hr)	10,34	10,24	9,89	9,59	9,38	9,79
COP for Heating (w/w)	3,46	3,3	2,82	3,14	2,9	3,07
Energy Class (cooling/heating)	B/B	C/C	C/D	C/D	D/D	C/D
Noise level - Indoor Unit (dBA) - max	35	35	38	43	47	35+37
Noise level - Indoor Unit (dBA) - min	30	30	33	38	40	30+33
Noise level - Outdoor Unit (dBA)	50	50	51	54	58	61
Dehumidification - Liters/h	0,8	0,9	1,5	2,4	2,7	1,5
Air Flow - max (CFM)	250	250	340	390	570	250+340
Refrigerant type	R407c	R407c	R407c	R407c	R407c	R407c
Refrigerant charge volume (kg)	0,7	1,15	1,18	2,02	2,12	1,12+1,14
Climate Class	T1	T1	T1	T1	T1	T1
<b>FEATURES</b>						
6th Sense	Yes	Yes	Yes	Yes	Yes	Yes
TURBO cool (Jet)	Yes/Jet	Yes / Jet	Yes / Jet	Yes / Jet	Yes / Jet	Yes / Jet
Timer on-off 24h	Yes	Yes	Yes	Yes	Yes	Yes
Temperature display on remote control	Yes	Yes	Yes	Yes	Yes	Yes
Real Time Clock on remote control	No	No	No	No	No	No
Sleep Mode	Yes	Yes	Yes	Yes	Yes	Yes
Automatic air swing	Yes	Yes	Yes	Yes	Yes	Yes
Fan Only	Yes	Yes	Yes	Yes	Yes	Yes
No. of cooling/heating speeds	4 (3 Speeds + Auto)	4 (3 Speeds + Auto)	4 (3 Speeds + Auto)	4 (3 Speeds + Auto)	4 (3 Speeds + Auto)	4 (3 Speeds + Auto)
Twin Flaps	No	No	No	Yes	Yes	No
Wide angle air swing	120	120	120	120	120	120
Auto restart after blackout	Yes (by default setting)	Yes (by default setting)	Yes (by default setting)	Yes (by default setting)	Yes (by default setting)	Yes (by default setting)
Auto Defrost for outdoor unit	Yes	Yes	Yes	Yes	Yes	Yes
Removable, washable Panel	Yes	Yes	Yes	Yes	Yes	Yes
compressor type	Rotary	Rotary	Rotary	Rotary	Rotary	Rotary
<b>CONTROLS</b>						
Remote Control	Yes	Yes	Yes	Yes	Yes	Yes
<b>AIR PURIFICATION</b>						
Anti bacterial dust filter - washable	Yes	Yes	Yes	Yes	Yes	Yes
Active Carbon filter	Yes	Yes	Yes	Yes	Yes	Yes
<b>ELECTRICAL RATINGS</b>						
Volts/Frequency (Hz)	220-240V/50Hz	220-240V/50Hz	220-240V/50Hz	220-240V/50Hz	220-240V/50Hz	220-240V/50Hz
Fuse Size (Amps)	20	20	20	25	32	
Ampere (A) - cooling	3,5	4,4	5,8	10,0	12,1	11,0
Power input (W) - cooling	761	931	1219	1990	2485	2204
Ampere (A) - heating	3,3	4,2	6,6	9,8	12,6	10,7
Power input (W) - heating	726	898	1418	1967	2572	2191
LRA (Lock Rotor Amps)	15	22	31	45	53	22+31
Power Cord Length (m) - Cabinet to Wall	1,5	1,5	1,5	1,5	1,5	1,5
<b>DIMENSIONS</b>						
Indoor Unit (WidthxHeightxD) (mm)	770x240x179	770x240x179	770x240x179	1025x313x203	1025x313x203	770x240x179
Indoor Unit 2 (WidthxHeightxD) (mm)						770x240x179
Outdoor Unit (WidthxHeightxD) (mm)	755x530x252	755x530x252	755x530x252	832x702x380	832x702x380	890x793x414
Weight indoor/outdoor (Kg)	8/24	8/30	8/34	16/58	16/60	8/64

# TECHNICAL SPECIFICATIONS R407c

R407c	GREEN SLIM SINGLE WITH LED					DUAL
Model number	AMB 966	AMB 967	AMB 968	AMB 969	AMB 970	AMB 971
12 NC	8528 966 10000	8528 967 10000	8528 968 10000	8528 969 10000	8528 970 10000	8528 971 10000
EAN Code	80 03437 76229 1	80 03437 76230 7	80 03437 76231 4	80 03437 76232 1	80 03437 76233 8	80 03437 76234 5
<b>MAIN FEATURES</b>						
Air conditioner type	SLIM series Split Heat / Cool	SLIM series Split Heat / Cool	SLIM series Split Heat/Cool	SLIM series Split Heat / Cool	SLIM series Split Heat / Cool	Multi Split SLIM - 2Compr Heat / Cool
Colour (indoor/outdoor)	White / Gray	White / Gray	White / Gray	White / Gray	White / Gray	White / Gray
<b>PERFORMANCE</b>						
Cooling capacity - BTU/h	7865	9526	12061	19080	23315	9430+12151
Cooling capacity - Watt	2305	2792	3535	5592	6833	2764+3561
Heating capacity - BTU/h	8575	10113	13648	21073	25456	9895+13054
Heating capacity - Watt	2513	2964	4000	6176	7460	2900+3826
EER cooling (Btu/watt hr)	10,34	10,24	9,89	9,59	9,38	9,79
COP for Heating (w/w)	3,46	3,3	2,82	3,14	2,9	3,07
Energy Class (cooling/heating)	B/B	C/C	C/D	C/D	D/D	C/D
Noise level - Indoor Unit (dBA) - max	35	35	38	43	47	35+37
Noise level - Indoor Unit (dBA) - min	30	30	33	38	40	30+33
Noise level - Outdoor Unit (dBA)	50	50	51	54	58	61
Dehumidification - Liters/h	0,8	0,9	1,5	2,4	2,7	1,5
Air Flow - max (CFM)	250	250	340	390	570	250+340
Refrigerant type	R407c	R407c	R407c	R407c	R407c	R407c
Refrigerant charge volume (kg)	0,7	1,15	1,18	2,02	2,12	1,12+1,14
Climate Class	T1	T1	T1	T1	T1	T1
<b>FEATURES</b>						
6th Sense	Yes	Yes	Yes	Yes	Yes	Yes
TURBO cool (Jet)	Yes/Jet	Yes / Jet	Yes / Jet	Yes / Jet	Yes / Jet	Yes / Jet
Timer on-off 24h	Yes	Yes	Yes	Yes	Yes	Yes
Temperature display on remote control	Yes	Yes	Yes	Yes	Yes	Yes
Temperature display on indoor unit	Yes- on LED display	Yes- on LED display	Yes- on LED display	Yes- on LED display	Yes- on LED display	Yes- on LED display
Real Time Clock on remote control	No	No	No	No	No	No
Sleep Mode	Yes	Yes	Yes	Yes	Yes	Yes
Automatic air swing	Yes	Yes	Yes	Yes	Yes	Yes
Fan Only	Yes	Yes	Yes	Yes	Yes	Yes
No. of cooling/heating speeds	4 (3 Speeds + Auto)	4 (3 Speeds + Auto)	4 (3 Speeds + Auto)	4 (3 Speeds + Auto)	4 (3 Speeds + Auto)	4 (3 Speeds + Auto)
Twin Flaps	No	No	No	Yes	Yes	No
Wide angle air swing	120	120	120	120	120	120
Auto restart after blackout	Yes (by default setting)	Yes (by default setting)	Yes (by default setting)	Yes (by default setting)	Yes (by default setting)	Yes (by default setting)
Auto Defrost for outdoor unit	Yes	Yes	Yes	Yes	Yes	Yes
Removable, washable Panel	Yes	Yes	Yes	Yes	Yes	Yes
compressor type	Rotary	Rotary	Rotary	Rotary	Rotary	Rotary
<b>CONTROLS</b>						
Remote Control	Yes	Yes	Yes	Yes	Yes	Yes
LED display on IDU	Yes	Yes	Yes	Yes	Yes	Yes
<b>AIR PURIFICATION</b>						
Anti bacterial dust filter - washable	Yes	Yes	Yes	Yes	Yes	Yes
Electrostatic filter	Yes	Yes	Yes	Yes	Yes	Yes
PHOTIC CATALYST filter	Yes	Yes	Yes	Yes	Yes	Yes
<b>ELECTRICAL RATINGS</b>						
Volts/Frequency (Hz)	220-240V/50Hz	220-240V/50Hz	220-240V/50Hz	220-240V/50Hz	220-240V/50Hz	220-240V/50Hz
Fuse Size (Amps)	20	20	20	25	32	
Ampere (A) - cooling	3,5	4,4	5,8	10,0	12,1	11,0
Power input (W) - cooling	761	931	1219	1990	2485	2204
Ampere (A) - heating	3,3	4,2	6,6	9,8	12,6	10,7
Power input (W) - heating	726	898	1418	1967	2572	2191
LRA (Lock Rotor Amps)	15	22	31	45	53	22+31
Power Cord Length (m) - Cabinet to Wall	1,5	1,5	1,5	1,5	1,5	1,5
<b>DIMENSIONS</b>						
Indoor Unit (WidthxHeightxDPTH) (mm)	770x240x179	770x240x179	770x240x179	1025x313x203	1025x313x203	770x240x179
Indoor Unit 2 (WidthxHeightxDPTH) (mm)						770x240x179
Outdoor Unit (WidthxHeightxDPTH) (mm)	755x530x252	755x530x252	755x530x252	832x702x380	832x702x380	890x793x414
Weight indoor/outdoor (Kg)	8/24	8/30	8/34	16/58	16/60	8/64

# TECHNICAL SPECIFICATIONS R410a

R410a	DESIGN SERIES SINGLE FLAT					DUAL	
Model number	AMC 990	AMC 991	AMC 992	AMC 993	AMC 994	AMD 060	AMD 061
12 NC	8528 990 10000	8528 991 10000	8528 992 10000	8528 993 10000	8528 994 10000	8530 060 01000	8530 061 01000
EAN Code	80 03437 77486 7	80 03437 77487 4	80 03437 77488 1	80 03437 77489 9	80 03437 77490 4	80 03437 797132	80 03437 79714 9
<b>MAIN FEATURES</b>							
Air conditioner type	Design Series Flat	Design Series Flat	Design Series Flat	Design Series Flat	Design Series Flat	Design Series Flat	Design Series Flat
	Heat / Cool	Heat / Cool	Heat/Cool	Heat / Cool	Heat / Cool	Heat / Cool	Heat / Cool
Colour (indoor/outdoor)	White / White	White / White	White / White	White / White	White / White	White	White
<b>PERFORMANCES</b>							
Cooling capacity - BTU/h	7700	9175	12500	18000	23000	9000 X2	900+12000
Cooling capacity - Watt	2257	2689	3664	5275	6741	2667x2	2667+3517
Heating capacity - BTU/h	7700	9700	13500	20000	25500	9200x2	9200+12200
Heating capacity - Watt	2257	2843	3957	5862	7474	2696x2	2696+3575
EER cooling (Btu/watt hr)	11,43	11,43	11,63	10,43	10,27	10,99	10,28
COP for Heating (w/w)	3,61	3,69	3,45	3,67	3,21	3,38	3,20
Energy Class (cooling/heating)	A/A	A/A	A/B	B/A	B/C	A/C	B/C
Noise level - Indoor Unit (dBA) - max	33	33	37	44	46	35	35/38
Noise level - Indoor Unit (dBA) - min	27	26	31	39	42	28	28/31
Noise level - Outdoor Unit (dBA)	50	50	54	55	55	57	57
Dehumidification - Liters/h	1,2	1,2	1,5	2,4	2,8	1,2+1,2	1,2+1,5
Air Flow - max (CFM)	250	250	340	470	570	265	265/295
Refrigerant type	R410a	R410a	R410a	R410a	R410a	R410a	R410a
Refrigerant charge volume (kg)	0,95	1,0	1,2	1,7	2,35	0,96+0,96	0,91+1,25
Climate Class	T1	T1	T1	T1	T1	T1	T1
<b>FEATURES</b>							
6th Sense	Yes	Yes	Yes	Yes	Yes	Yes	Yes
Round U	Yes	Yes	Yes	Yes	Yes	Yes	Yes
TURBO cool (Jet)	Yes / Jet	Yes / Jet	Yes / Jet	Yes / Jet	Yes / Jet	Yes / Jet	Yes / Jet
Timer on-off 24h	Yes	Yes	Yes	Yes	Yes	Yes	Yes
Temperature display on remote control	Yes	Yes	Yes	Yes	Yes	Yes	Yes
Real Time Clock on remote control	Yes	Yes	Yes	Yes	Yes	Yes	Yes
Sleep Mode	Yes	Yes	Yes	Yes	Yes	Yes	Yes
Automatic air swing	Yes	Yes	Yes	Yes	Yes	Yes	Yes
Fan Only	Yes	Yes	Yes	Yes	Yes	Yes	Yes
No. of cooling/heating speeds	4 (3 Speeds + Auto)	4 (3 Speeds + Auto)	4 (3 Speeds + Auto)	4 (3 Speeds + Auto)	4 (3 Speeds + Auto)	4 (3 Speeds + Auto)	4 (3 Speeds + Auto)
Twin Flaps	Yes	Yes	Yes	Yes	Yes	Yes	Yes
Wide angle air swing	94	94	94	95	95	94	94
Auto restart after blackout	Yes (by default)	Yes (by default)	Yes (by default)	Yes (by default)	Yes (by default)	Yes (by default)	Yes (by default)
Auto Defrost for outdoor unit	Yes	Yes	Yes	Yes	Yes	Yes	Yes
Removable, washable Panel	Yes	Yes	Yes	Yes	Yes	Yes	Yes
compressor type	Rotary	Rotary	Rotary	Rotary	Rotary	Rotary x 2	Rotary x 2
<b>CONTROLS</b>							
Remote Control ROUND U	Yes	Yes	Yes	Yes	Yes	Yes	Yes
<b>AIR PURIFICATION</b>							
Anti dust filter - washable	Yes	Yes	Yes	Yes	Yes	Yes	Yes
HEPA filter	Optional	Optional	Optional	Optional	Optional	No	No
PHOTIC CATALYST filter	Yes	Yes	Yes	Yes	Yes	Yes	Yes
Ion Filter	No	No	No	No	No	No	No
<b>ELECTRICAL RATINGS</b>							
Volts/Frequency (Hz)	220-240V/50Hz	220-240V/50Hz	220-240V/50Hz	220-240V/50Hz	220-240V/50Hz	220-240V/50Hz	220-240V/50Hz
Fuse Size (Amps)	10	10	15	25	25	25A	25A
Ampere (A) - cooling	2,98	3,87	4,95	7,98	10,25	7,64	9,45
Power input (W) - cooling	676	876	1122	1813	2357	1656	2053
Ampere (A) - heating	2,89	3,59	5,17	7,36	10,57	7,33	9
Power input (W) - heating	654,5	814	1171	1673	2431	1595	1960
LRA (Lock Rotor Amps)	17	18	32	40	60	19,6+19,6	19,6+31
Power Cord Length (m) - Cabinet to Wall	2	2	2	2	2	6,8	6,8
<b>DIMENSIONS</b>							
Indoor Unit (WidthxHeightxDepth) (mm)	830x285x189	830x285x189	830x285x189	1020x310x228	1020x310x228	895x365x280	895x365x280
Indoor Unit 2 (WidthxHeightxDepth) (mm)	No	No	No	No	No	895x365x280	895x365x280
Outdoor Unit (WidthxHeightxDepth) (mm)	660x428x255	848x540x320	848x540x320	848x592x320	950x840x412	1100x755x450	1100x755x450
Weight indoor/outdoor (Kg)	11/25	11/30	11/40	13/45	13/75	14/68	14/68



# TECHNICAL SPECIFICATIONS R410a

R410a	ECO SINGLE					ECO DUAL	
Model number	AMB 951	AMB 953	AMB 955	AMB 957	AMB 959	AMB 972	AMB 973
12 NC	8528 951 10000	8528 953 10000	8528 955 10000	8528 957 10000	8528 959 10000	8528 972 10000	8528 973 10000
EAN Code	80 03437 75379 4	80 03437 75381 7	80 03437 75383 1	80 03437 75385 5	80 03437 75387 9	80 03437 76434 9	80 03437 76435 6
<b>MAIN FEATURES</b>							
Air conditioner type	ECO series Split	ECO series Split	ECO series Split	ECO series Split	ECO series Split	Multi Split Eco - 2Compr	Multi Split Eco - 2Compr
	Heat / Cool	Heat / Cool	Heat/Cool	Heat / Cool	Heat / Cool	Heat / Cool	Heat / Cool
Colour (indoor/outdoor)	White / Gray	White / Gray	White / Gray	White / Gray	White / Gray	White / Gray	White / Gray
<b>PERFORMANCES</b>							
Cooling capacity - BTU/h	7421	9581	12775	18384	23433	9000 X2	9000 + 12000
Cooling capacity - Watt	2175	2808	3744	5388	6867	2600x2	2600+3500
Heating capacity - BTU/h	7994	11062	14252	19951	25565	10000 X2	9500 + 13500
Heating capacity - Watt	2343	3242	4177	5847	7493	2900x2	2780+3950
EER cooling (Btu/watt hr)	11,74	11,77	11,16	10,71	10,54	10	10
COP for Heating (w/w)	3,9	3,84	3,42	3,39	3,52	3,26	3,29
Energy Class (cooling/heating)	A/A	A/A	A/B	B/C	B/C	C/C	C/C
Noise level - Indoor Unit (dBA) - max	33	33	37	44	46	37	37+40
Noise level - Indoor Unit (dBA) - min	27	27	31	39	42	27	27+30
Noise level - Outdoor Unit (dBA)	50	50	54	54	56	58	58
Dehumidification - Liters/h	0,8	0,9	1,5	2,4	2,8	0,9+0,9	0,9+1,2
Air Flow - max (CFM)	250	250	340	470	570	250+250	420+340
Refrigerant type	R410A	R410A	R410A	R410A	R410A	R410a	R410a
Refrigerant charge volume (kg)	0,8	1,14	1,27	1,76	1,76	1.2+1.1	0.98+1.26
Climate Class	T1	T1	T1	T1	T1	T1	T1
<b>FEATURES</b>							
6th Sense	Yes	Yes	Yes	Yes	Yes	Yes	Yes
Round U	Yes	Yes	Yes	Yes	Yes	Yes	Yes
TURBO cool (Jet)	Yes / Jet	Yes / Jet	Yes / Jet	Yes / Jet	Yes / Jet	Yes / Jet	Yes / Jet
Timer on-off 24h	Yes	Yes	Yes	Yes	Yes	Yes	Yes
Temperature display on remote control	Yes	Yes	Yes	Yes	Yes	Yes	Yes
Real Time Clock on remote control	Yes	Yes	Yes	Yes	Yes	Yes	Yes
Sleep Mode	Yes	Yes	Yes	Yes	Yes	Yes	Yes
Automatic air swing	Yes	Yes	Yes	Yes	Yes	Yes	Yes
Fan Only	Yes	Yes	Yes	Yes	Yes	Yes	Yes
No. of cooling/heating speeds	4 (3 Speeds + Auto)	4 (3 Speeds + Auto)	4 (3 Speeds + Auto)	4 (3 Speeds + Auto)	4 (3 Speeds + Auto)	4 (3 Speeds + Auto)	4 (3 Speeds + Auto)
Twin Flaps	Yes	Yes	Yes	Yes	Yes	Yes	Yes
Wide angle air swing	120	120	120	120	120	120	120
Auto restart after blackout	Yes (by default)	Yes (by default)	Yes (by default)	Yes (by default)	Yes (by default)	Yes (by default)	Yes (by default)
Auto Defrost for outdoor unit	Yes	Yes	Yes	Yes	Yes	Yes	Yes
Removable, washable Panel	Yes	Yes	Yes	Yes	Yes	Yes	Yes
compressor type	Rotary	Rotary	Rotary	Rotary	Rotary	Rotary x 2	Rotary x 2
<b>CONTROLS</b>							
Remote Control NEW ROUND U	Yes	Yes	Yes	Yes	Yes	Yes	Yes
<b>AIR PURIFICATION</b>							
Anti bacterial dust filter - washable	Yes	Yes	Yes	Yes	Yes	Yes	Yes
HEPA filter	Yes	Yes	Yes	Yes	Yes	Yes	Yes
PHOTIC CATALYST filter	Yes	Yes	Yes	Yes	Yes	No	No
Ion Filter	No	No	No	No	No	Yes	Yes
<b>ELECTRICAL RATINGS</b>							
Volts/Frequency (Hz)	220-240V/50Hz	220-240V/50Hz	220-240V/50Hz	220-240V/50Hz	220-240V/50Hz	220-240V/50Hz	220-240V/50Hz
Fuse Size (Amps)	20	20	20	25	32		
Ampere (A) - cooling	3	3,9	5,4	8,4	11,9	8,4	10,2
Power input (W) - cooling	632	814	1145	1716	2222	1800	2100
Ampere (A) - heating	2,8	4	5,7	8,4	11,8	8,4	9,6
Power input (W) - heating	601	844	1221	1725	2129	1800	2050
LRA (Lock Rotor Amps)	20	22	33	47	58	18+18	24 + 30
Power Cord Length (m) - Cabinet to Wall	1,5	1,5	1,5	1,5	1,5	1,5	1,5
<b>DIMENSIONS</b>							
Indoor Unit (WidthxHeightxDepth) (mm)	800x270x168	800x270x168	890x270x168	1025x313x203	1025x313x203	800x270x168	800x270x168
Indoor Unit 2 (WidthxHeightxDepth) (mm)	No	No	No	No	No	800x270x168	890x270x168
Outdoor Unit (WidthxHeightxDepth) (mm)	755x530x252	755x530x252	755x530x252	832x702x380	832x702x380	832x702x380	832x702x380
Weight indoor/outdoor (Kg)	8,5/34	8,5/34	11/38	14/58		9/9/70	9/11/74

# TECHNICAL SPECIFICATIONS R410a

R410a	INVERTER - DESIGN SERIES FLAT		ECO INVERTER	
Model number	AMC 996	AMC 998	AMB 869/G	AMB 868/G
12 NC	8528 996 10000	8528 998 61000	8528 869 10000	8528 868 10100
EAN Code	80 03437 77506 2	80 03437 77508 6	8003437 75389 3	8003437 75388 6
<b>MAIN FEATURES</b>				
Air conditioner type	Design Series INVERTER	Design Series INVERTER	ECO INVERTER	ECO INVERTER
	Heat / Cool	Heat / Cool	Heat / Cool	Heat / Cool
Colour (indoor/outdoor)	White / White	White / White	White / Gray	White / Gray
<b>PERFORMANCES</b>				
Cooling capacity - BTU/h	9000	12657	9000@56Hz	12000@75Hz
Cooling capacity - Watt	2638	3710	2630	3500
Heating capacity - BTU/h	9500	14125	10000@58Hz	13000@77Hz
Heating capacity - Watt	2784	4140	2930	3810
EER cooling (Btu/watt hr)	12,15	11,60	11,26	10,95
COP for Heating (w/w)	3,65	3,41	3,62	3,4
Energy Class (cooling/heating)	A/A	A/B	A/A	A/B
Noise level - Indoor Unit (dBA) - max	35	37	35	37
Noise level - Indoor Unit (dBA) - min	27	30	27	30
Noise level - Outdoor Unit (dBA)	52	52	54	54
Dehumidification - Liters/h	1,2	1,6	0,9	1,5
Air Flow - max (CFM)	265	324	250	340
Refrigerant type	R410a	R410a	R410A	R410A
Refrigerant charge volume (kg)	1,25	1,25	1,1	1,26
Climate Class	T1	T1	T1	T1
<b>FEATURES</b>				
6th Sense	Yes	Yes	Yes	Yes
Round U	Yes	Yes	Yes	Yes
TURBO cool (Jet)	Yes / Turbo	Yes / Turbo	Yes / Turbo	Yes / Turbo
Timer on-off 24h	Yes	Yes	Yes	Yes
Temperature display on remote control	Yes	Yes	Yes	Yes
Real Time Clock on remote control	Yes	Yes	Yes	Yes
Sleep Mode	Yes	Yes	Yes	Yes
Automatic air swing	Yes	Yes	Yes	Yes
Fan Only	Yes	Yes	Yes	Yes
No. of cooling/heating speeds	4 (3 Speeds + Auto)	4 (3 Speeds + Auto)	4 (3 Speeds + Auto)	4 (3 Speeds + Auto)
Twin Flaps	Yes	Yes	Yes	Yes
Wide angle air swing	94	94	120	120
Auto restart after blackout	Yes (by default)	Yes (by default)	Yes (by default)	Yes (by default)
Auto Defrost for outdoor unit	Yes	Yes	Yes	Yes
Removable, washable Panel	Yes	Yes	Yes	Yes
compressor type	Scroll	Scroll	Rotary	Rotary
<b>CONTROLS</b>				
Remote Control	Yes	Yes	Yes	Yes
<b>AIR PURIFICATION</b>				
Anti dust filter - washable	Yes	Yes	Yes	Yes
Active Carbon filter	No	No	Yes	Yes
HEPA filter	No	No	Yes	Yes
ION filter	No	No	No	No
<b>ELECTRICAL RATINGS</b>				
Volts/Frequency (Hz)	220-240V/50-60Hz	220-240V/50-60Hz	220-240V/50-60Hz	220-240V/50-60Hz
Fuse Size (Amps)	10	15	20	20
Ampere (A) - cooling	3,17	4,83	3,7	5,2
Power input (W) - cooling	799	1098	799	1098
Ampere (A) - heating	3,48	5,11	3,8	4,9
Power input (W) - heating	819	1259	810	1078
LRA (Lock Rotor Amps)	33,50	33,50	45	45
Power Cord Length (m) - Cabinet to Wall	5,2	5,2	2	2
<b>DIMENSIONS</b>				
Indoor Unit (WidthxHeightxDepth) (mm)	830x285x189	830x285x189	800x270x168	890x270x168
Outdoor Unit (WidthxHeightxDepth) (mm)	848x540x320	848x540x320	755x530x252	755x530x252
Weight indoor/outdoor (Kg)	11/41	11/41	8,5/39	10/40

# TECHNICAL SPECIFICATIONS R22

R22	DESIGN SERIES RANGE TROPICAL				
Model number	AMC 985	AMC 986	AMC 987	AMC 988	AMC 989
12 NC	8528 985 10000	8528 986 10000	8528 987 10000	8528 988 10000	8528 989 10000
EAN Code	80 03437 77481 2	80 03437 77482 9	80 03437 77483 6	80 03437 77484 3	80 03437 77485 0
<b>MAIN FEATURES</b>					
Air conditioner type	Design Series Tropical	Design Series Tropical	Design Series Tropical	Design Series Tropical	Design Series Tropical
	Heat/Cool	Heat/Cool	Heat/Cool	Heat/Cool	Heat/Cool
Colour (indoor/outdoor)	Global White/Almond White	Global White/Almond White	Global White/Almond White	Global White/Almond White	Global White/Almond White
<b>PERFORMANCES</b>					
Cooling capacity - BTU/h	7000	9000	11430	17060	22000
Cooling capacity - Watt	2052	2638	3350	5000	6400
Heating capacity - BTU/h	7550	9500	12966	18600	23000
Heating capacity - Watt	2213	2784	3800	5451	6741
EER cooling (Btu/watt hr)	9,70	9,38	8,91	8,91	8,44
COP for Heating (w/w)	3,23	3,01	2,80	2,66	2,68
Energy Class (cooling/heating)	C/C	D/D	D/D	D/E	E/E
Noise level - Indoor Unit (dBA) - max	34	35	39	43	50
Noise level - Indoor Unit (dBA) - min	30	30	33	39	41
Noise level - Outdoor Unit (dBA)	48	50	51	54	57
Dehumidification - Liters/h	0,9	0,9	1,4	1,8	2
Air Flow - max (CFM)	190	270	300	530	710
Refrigerant type	R22	R22	R22	R22	R22
Refrigerant charge volume (kg)	0,73	0,85	1,2	1,6	2,3
Climate Class	T1	T1	T1	T1	T1
<b>FEATURES</b>					
6th Sense	Yes	Yes	Yes	Yes	Yes
TURBO cool (Jet)	Yes/Jet	Yes/Jet	Yes/Jet	Yes/Jet	Yes/Jet
Timer on-off 24h	Yes	Yes	Yes	Yes	Yes
Temperature display on remote control	Yes	Yes	Yes	Yes	Yes
Real Time Clock on remote control	Yes	Yes	Yes	Yes	Yes
Key lock on remote control	No	No	No	No	No
Sleep Mode	Yes	Yes	Yes	Yes	Yes
Automatic air swing	Yes	Yes	Yes	Yes	Yes
Fan Only	Yes	Yes	Yes	Yes	Yes
No. of cooling/heating speeds	4 (3 Speeds + Auto)	4 (3 Speeds + Auto)	4 (3 Speeds + Auto)	4 (3 Speeds + Auto)	4 (3 Speeds + Auto)
Twin Flaps	No	No	No	Yes	Yes
Wide angle air swing	90	90	90	90	80
Auto restart after blackout	Yes (by default)	Yes (by default)	Yes (by default)	Yes (by default)	Yes (by default)
Auto Defrost for outdoor unit	Yes	Yes	Yes	Yes	Yes
Removable, washable Panel	Yes	Yes	Yes	Yes	Yes
compressor type	Rotary	Rotary	Rotary	Rotary	Rotary
<b>CONTROLS</b>					
Remote Control	Yes	Yes	Yes	Yes	Yes
<b>AIR PURIFICATION</b>					
NANO-metre Catalyst filter	Yes	Yes	Yes	Yes	Yes
Germ-killing filter	Yes	Yes	Yes	Yes	Yes
HEPA filter	No	No	No	No	No
ION filter	No	No	No	No	No
<b>ELECTRICAL RATINGS</b>					
Volts/Frequency (Hz)	220-240V/50Hz	220-240V/50Hz	220-240V/50Hz	220-240V/50Hz	220-240V/50Hz
Fuse Size (Amps)	20	20	20	25	32
Ampere (A) - cooling	3	4,1	5,4	8,4	11,5
Power input (W) - cooling	685	925	1220	1940	2600
Ampere (A) - heating	3	4	6,4	9	11,5
Power input (W) - heating	675	908	1430	2045	2600
LRA (Lock Rotor Amps)	15	22	31	45	53
Power Cord Length (m) - Cabinet to Wall	1,5	1,5	1,5	1,7	2,5
<b>DIMENSIONS</b>					
Indoor Unit (WidthxHeightxDepth) (mm)	800x290x185	800x290x185	800x290x185	920x295x220	1080x330x230
Outdoor Unit (WidthxHeightxDepth) (mm)	665x500x295	665x500x295	830x500x310	860x690x370	935x790x415
Weight indoor/outdoor (Kg)	10/26	10/27	10/37	13/50	15/70

# TECHNICAL SPECIFICATIONS R22

R22	CLASSIC RANGE TROPICAL				
Model number	AMB 859	AMB 857	AMB 867	AMB 877	AMB 887
12 NC	8528 859 10000	8528 857 10000	8528 867 10000	8528 877 10000	8528 887 10000
EAN Code	80 03437 74275 0	80 03437 74263 7	80 03437 74265 1	80 03437 74268 2	80 03437 74271 2
<b>MAIN FEATURES</b>					
Air conditioner type	CLASSIC Split	CLASSIC Split	CLASSIC Split	CLASSIC Split	CLASSIC Split
	Heat / Cool	Heat / Cool	Heat/Cool	Heat / Cool	Heat / Cool
Colour (indoor/outdoor)	White / Gray	White / Gray	White / Gray	White / Gray	White / Gray
<b>PERFORMANCES</b>					
Cooling capacity - BTU/h	7000	9000	12000	18000	22000
Cooling capacity - Watt	2050	2600	3500	5250	6400
Heating capacity - BTU/h	7500	9500	13000	18500	22500
Heating capacity - Watt	2200	2750	3800	5400	6600
EER cooling (Btu/watt hr)	9,59	10,23	9,52	8,57	8,15
COP for Heating (w/w)	2,93	3,09	3	2,58	2,44
Energy Class (cooling/heating)	C/B	C/D	D/D	E/F	F/F
Noise level - Indoor Unit (dBA) - max	33	33	37	43	47
Noise level - Indoor Unit (dBA) - min	27	27	30	38	40
Noise level - Outdoor Unit (dBA)	50	50	51	54	58
Dehumidification - Liters/h	0,9	0,9	1,5	2,4	2,7
Air Flow - max (CFM)	250	250	340	390	470
Refrigerant type	R22	R22	R22	R22	R22
Refrigerant charge volume (kg)	0,51	0,86	1,1	1,92	2,36
Climate Class	T1	T1	T1	T1	T1
<b>FEATURES</b>					
6th Sense	Yes	Yes	Yes	Yes	Yes
TURBO cool (Jet)	Yes/Jet	Yes/Jet	Yes/Jet	Yes/Jet	Yes/Jet
Timer on-off 24h	Yes	Yes	Yes	Yes	Yes
Temperature display on remote control	Yes	Yes	Yes	Yes	Yes
Real Time Clock on remote control	Yes	Yes	Yes	Yes	Yes
Key lock on remote control	Yes	Yes	Yes	Yes	Yes
Sleep Mode	Yes	Yes	Yes	Yes	Yes
Automatic air swing	Yes	Yes	Yes	Yes	Yes
Fan Only	Yes	Yes	Yes	Yes	Yes
No. of cooling/heating speeds	4 (3 Speeds + Auto)	4 (3 Speeds + Auto)	4 (3 Speeds + Auto)	4 (3 Speeds + Auto)	4 (3 Speeds + Auto)
Twin Flaps	Yes	Yes	Yes	Yes	Yes
Wide angle air swing	120	120	120	120	120
Auto restart after blackout	Yes (by default)	Yes (by default)	Yes (by default)	Yes (by default)	Yes (by default)
Auto Defrost for outdoor unit	Yes	Yes	Yes	Yes	Yes
Removable, washable Panel	Yes	Yes	Yes	Yes	Yes
compressor type	Rotary	Rotary	Rotary	Rotary	Rotary
<b>CONTROLS</b>					
Remote Control	Yes, exclusive 2004	Yes, exclusive 2004	Yes, exclusive 2004	Yes, exclusive 2004	Yes, exclusive 2004
<b>AIR PURIFICATION</b>					
Anti bacterial dust filter - washable	Yes	Yes	Yes	Yes	Yes
Active Carbon filter	No	No	No	No	No
HEPA filter	Yes	Yes	Yes	Yes	Yes
ION filter	Yes	Yes	Yes	Yes	Yes
<b>ELECTRICAL RATINGS</b>					
Volts/Frequency (Hz)	220-240V/50Hz	220-240V/50Hz	220-240V/50Hz	220-240V/50Hz	220-240V/50Hz
Fuse Size (Amps)	20	20	20	25	32
Ampere (A) - cooling	3,4	4,1	5,8	9,7	12,5
Power input (W) - cooling	730	880	1260	2100	2700
Ampere (A) - heating	3,5	4,2	5,9	9,7	12,5
Power input (W) - heating	750	900	1280	2100	2700
LRA (Lock Rotor Amps)	15	22	26	49	52
Power Cord Length (m) - Cabinet to Wall	1,5	1,5	1,5	1,5	1,5
<b>DIMENSIONS</b>					
Indoor Unit (WidthxHeightxDepth) (mm)	800x270x168	800x270x168	890x270x168	1025x313x203	1025x313x203
Outdoor Unit (WidthxHeightxDepth) (mm)	755x530x252	755x530x252	755x530x252	800x637x268	832x702x380
Weight indoor/outdoor (Kg)	8,5/30	9/30	11/42	16/48	16/66

# TECHNICAL SPECIFICATIONS R22

R22	SUPER TROPICAL		SLIM SINGLE	
Model number	AMB 873	AMB 893	AMB 854	AMB 864
12 NC	8528 873 10100	8528 893 10100	8528 854 10000	8528 864 10000
EAN Code	80 03437 75546 0	80 03437 75547 7	80 03437 74972 8	80 03437 74974 2
<b>MAIN FEATURES</b>				
Air conditioner type	T3 Split	T3 Split	SLIM series	SLIM series
	Cool Only	Cool Only	Heat / Cool	Heat / Cool
Colour (indoor/outdoor)	White / Gray	White / Gray	White / Gray	White / Gray
<b>PERFORMANCES</b>				
Cooling capacity - BTU/h / T3 conditions	18000	24000	9000	12000
Cooling capacity - Watt / T3 conditions	5200	7000	2600	3500
Heating capacity - BTU/h	-	-	9500	12400
Heating capacity - Watt	-	-	2750	3600
EER cooling (Btu/watt hr)	7,88	8,70	9,00	8,60
COP for Heating (w/w)	-	-	2,81	2,6
Energy Class (cooling/heating)	NA	NA	D/D	E/E
Noise level - Indoor Unit (dBA) - max	43	47	35	38
Noise level - Indoor Unit (dBA) - min	37	41	30	33
Noise level - Outdoor Unit (dBA)	54	58	50	51
Dehumidification - Liters/h	2,4	2,7	0,9	1,5
Air Flow - max (CFM)	470	570	240	270
Refrigerant type	R22	R22	R22	R22
Refrigerant charge volume (kg)	1,45	2,08	0,86	0,84
Climate Class	T3	T3	T1	T1
<b>FEATURES</b>				
6th Sense	Yes	Yes	Yes	Yes
TURBO cool (Jet)	Yes / Jet	Yes / Jet	Yes / Jet	Yes / Jet
Timer on-off 24h	Yes	Yes	Yes	Yes
Temperature display on remote control	Yes	Yes	Yes	Yes
Real Time Clock on remote control	Yes	Yes	No	No
Sleep Mode	Yes	Yes	Yes	Yes
Automatic air swing	Yes	Yes	Yes	Yes
Fan Only	Yes	Yes	Yes	Yes
No. of cooling/heating speeds	4 (3 Speeds + Auto)	4 (3 Speeds + Auto)	4 (3 Speeds + Auto)	4 (3 Speeds + Auto)
Twin Flaps	Yes	Yes	No	No
Wide angle air swing	120	120	120	120
Auto restart after blackout	Yes (by default)	Yes (by default)	Yes (by default)	Yes (by default)
Auto Defrost for outdoor unit	NA	NA	Yes	Yes
Removable, washable Panel	Yes	Yes	Yes	Yes
compressor type	Rotary	Rotary	Rotary	Rotary
<b>CONTROLS</b>				
Remote Control	Yes	Yes	Yes	Yes
<b>AIR PURIFICATION</b>				
Anti bacterial dust filter - washable	No	No	Yes	Yes
Active Carbon filter	Yes	Yes	Yes	Yes
HEPA filter	Yes	Yes	No	No
ION filter	Yes	Yes	No	No
<b>ELECTRICAL RATINGS</b>				
Volts/Frequency (Hz)	220-240V/50Hz	220-240V/50Hz	220-240V/50Hz	220-240V/50Hz
Fuse Size (Amps)	-	-	20	20
Ampere (A) - cooling	10,5 / 14,3	13 / 14,7	4,2	6,5
Power input (W) - cooling	2251 / 2781	2750 / 3221	980	1400
Ampere (A) - heating	-	-	4,2	6,5
Power input (W) - heating	-	-	980	1400
LRA (Lock Rotor Amps)	47	58	22	31
Power Cord Length (m) - Cabinet to Wall	1,5	1,5	1,5	1,5
<b>DIMENSIONS</b>				
Indoor Unit (WidthxHeightxDPTH) (mm)	1025x313x203	1025x313x203	770x240x179	770x240x179
Outdoor Unit (WidthxHeightxDPTH) (mm)	832x702x380	832x702x380	755x530x252	755x530x252
Weight indoor/outdoor (Kg)	14/50	14/56	8/30	8/34

# TECHNICAL SPECIFICATIONS R22

R22	WINDOW TROPICAL	WINDOW SUPER TROPICAL
Model number	AMB 758	AMB 796
12 NC	8528 758 10000	8528 796 10000
EAN Code	80 03437 74450 1	80 03437 74452 5
<b>MAIN FEATURES</b>		
Air conditioner type	Windows Electronics	Windows Electro-Mechanical
	Cooling only	Cooling Only
Colour (indoor)	Warm / Gray	Warm / Gray
<b>PERFORMANCES</b>		
Cooling capacity - BTU/h	8600	18000/13000
Watt - Cool	2500	5200
Heating capacity - BTU/h	-	-
Heating capacity - Watt	-	-
EER cooling (Btu/watt hr)	8,20	7,20
COP for Heating (w/w)	-	-
Energy Class (cooling/heating)	NA	NA
Noise level - Indoor Unit (dBA) - max	49	59
Noise level - Indoor Unit (dBA) - min	43	53
Noise level - Outdoor Unit (dBA)	57	62
Dehumidification - Liters/h	1	2
Air Flow - max (CFM)	360	870
Refrigerant type	R22	R22
Refrigerant charge volume (kg)	0,46	1,52
Climate Class	T1	T3
<b>FEATURES</b>		
6th Sense	Yes	-
TURBO cool (Jet)	Yes / Jet	-
Timer on-off 24h	Yes	No
Temperature display on remote control	Yes	No
Real time clock on remote control	No	No
Sleep Mode	Yes	No
Automatic air swing	Yes	Yes
Fan Only	Yes	Yes
No. of cooling/heating speeds	3 Speeds	3 Speeds
Twin Flaps	No	No
Wide angle air swing	120	120
Auto restart after blackout	No	No
Auto Defrost for outdoor unit	NA	NA
Easy to install	Yes	Yes
Removable, washable Panel	Yes	No
Compressor type	Rotary	Rotary
<b>CONTROLS</b>		
Remote Control	Yes	mechanical
<b>AIR PURIFICATION</b>		
Fresh Air (Exhaust)	Yes	Yes
Antibacterial dust filter - washable	No	No
HEPA filter	No	No
ION filter	No	No
<b>ELECTRICAL RATINGS</b>		
Volts/Frequency (Hz)	220-240V/50Hz	220-240V/50Hz
Fuse Size (Amps)	15	20
Ampere (A) - cooling	4,9	12,5
Power input (W) - cooling	1050	2500
Ampere (A) - heating	-	-
Power input (W) - heating	-	-
LRA (Lock Rotor Amps)	22	66
Power Cord Length (m) - Cabinet to Wall	1,5	1,5
<b>DIMENSIONS</b>		
Indoor Unit (WidthxHeightxDepth) (mm)	500x345x535	672x469x682
Outdoor Unit (WidthxHeightxDepth) (mm)	-	-
Weight indoor (Kg)	34	68

# TECHNICAL SPECIFICATIONS R410a

R410a	PORTABLES		
Model number	AMC 995	AMD 096	AMD 097
12 NC	8528 995 10000	8530 096 01000	8530 097 01000
EAN Code	80 03437 77491 1	80 03437 79576 3	80 03437 79577 0
<b>MAIN FEATURES</b>			
Air conditioner type	Portable	Portable	Portable
	Cool only	Heat / Cool	Heat / Cool
Colour (indoor/outdoor)	White	Silver	Blue Metallic
<b>PERFORMANCES</b>			
Cooling capacity - BTU/h	10646	8872	11260
Cooling capacity - Watt	2836	2600	3300
Heating capacity - BTU/h	-	4095	4095
Heating capacity - Watt	-	1200	1200
EER cooling (Btu/watt hr)	7,73	9,18	8,73
COP for Heating (w/w)	-	N/A	N/A
Energy Class (cooling/heating)	C	A	B
Noise level - Indoor Unit (dBA) - max	57,5	54	54
Noise level - Indoor Unit (dBA) - min	54	46	46
Noise level - Outdoor Unit (dBA)	-	-	-
Dehumidification - Liters/h	2	0,9	1
Air Flow - max (CFM)	180	400	400
Refrigerant type	R410a	R410a	R410a
Refrigerant charge volume (kg)	0,58	0,74	0,9
Climate Class	T1	T1	T1
<b>FEATURES</b>			
6th Sense	Yes	Yes	Yes
TURBO cool (Jet)	No	Yes	Yes
Timer on-off 24h	Yes	Yes	Yes
Temperature display on remote control	Yes	Yes	Yes
Electronic control panel + display temp	Yes	Yes	Yes
Real Time Clock on remote control	Yes	Yes	Yes
Sleep Mode	Yes	No	No
Automatic air swing	No	Yes	Yes
Fan Only	Yes	Yes (2+Auto)	Yes (2+Auto)
Fan motor	2	2	2
No. of cooling speeds	3	4	4
Twin Flaps	No	No	No
Wide angle air swing	No	No	No
Air Flow Directions	Top/Front	4	4
Auto restart after blackout	No	Yes	Yes
Auto Defrost for outdoor unit	No	No	No
Easy to install	Yes	Yes	Yes
Removable, washable Panel	No	No	No
Full Bucket light	Yes	Yes	Yes
compressor type	Rotary	Rotary	Rotary
<b>CONTROLS</b>			
Remote Control	Yes	Yes	Yes
Electronic control panel + display temp	Yes	Yes	Yes
Soft touch key pad	Yes	Yes	Yes
<b>AIR PURIFICATION</b>			
Anti bacterial dust filter	Yes	No	No
<b>ELECTRICAL RATINGS</b>			
Volts/Frequency (Hz)	220-240V/50Hz	220-240V/50Hz	220-240V/50Hz
Fuse Size (Amps)	15	20	20
Ampere (A) - cooling	5,2	4,4	5,9
Power input (W) - cooling	1248	966	1290
Ampere (A) - heating	-	5,5	5,5
Power input (W) - heating	-	N/A	N/A
LRA (Lock Rotor Amps)	24	23	29
Power Cord Length (m) - Cabinet to Wall	1,8	1,5	1,5
<b>DIMENSIONS</b>			
Indoor Unit (WidthxHeightxDepth) (mm)	455x856x370	450x845x500	450x845x500
Outdoor Unit (WidthxHeightxDepth) (mm)	-	-	-
Weight indoor/outdoor (Kg)	39	44	48

# TECHNICAL SPECIFICATIONS R407c/R22

R407c / R22	COMMERCIAL SPLIT SINGLE		CASSETTE		FLOOR CEILING
Model number	AMB 878 R407c	AMB 879 R22	AMB 888/G R407c	AMB 889/G R407c	AMB 974 R407c
12 NC	8528 878 10000	8528 879 10000	8528 888 10000	8528 889 10000	8528 974 10000
EAN Code	80 03437 75612 2	80 03437 75713 9	800 3437 75390 9	800 3437 75391 6	80 03437 76436 3
<b>MAIN FEATURES</b>					
Air conditioner type	Regular Split 30K Heat/Cool	Regular Split 30K Heat/Cool	Cassette Heat & Cool	Cassette Heat & Cool	Floor Ceiling type Heat/Cool
Colour (indoor/outdoor)	White / Gray	White / Gray	White / Gray	White / Gray	White / Gray
<b>PERFORMANCES</b>					
Cooling capacity - BTU/h	30000	30000	25327	43600	24000
Cooling capacity - Watt	8790	8790	7423	12800	7030
Heating capacity - BTU/h	33000	33000	27800	46600	26000
Heating capacity - Watt	9670	9670	8160	13650	7620
EER cooling (Btu/watt hr)	8,3	8,7	9,72	9,59	9,2
COP for Heating (w/w)	2,42	2,7	3,12	2,78	3
Energy Class (cooling/heating)	E/F	E/E	C/D	C/E	C/C
Noise level - Indoor Unit (dBA) - max	52	52	46	52	49
Noise level - Indoor Unit (dBA) - min	47	47	40	45	43
Noise level - Outdoor Unit (dBA)	62	62	60	63	58
Dehumidification - Liters/h	3,5	3,5	2,8	5	2,4
Air Flow - max (CFM)	770	770	650	950	650
Refrigerant type	R407c	R22	R407C	R407C	R407c
Refrigerant charge volume (kg)	2,8	2,96	2,38	3,98	2,24
Climate Class	T1	T1	T1	T1	T1
<b>FEATURES</b>					
6th Sense	Yes	Yes	Yes	Yes	Yes
TURBO cool (Jet)	Yes/Jet	Yes/Jet	Jet	Jet	Jet
Timer on-off 24h	Yes	Yes	Yes	Yes	Yes
Temperature display on remote control	Yes	Yes	Yes	Yes	Yes
Real Time Clock on remote control	No	No	No	No	No
Sleep Mode	Yes	Yes	Yes	Yes	Yes
Automatic air swing	Yes	Yes	Yes	Yes	Yes
Fan Only	Yes	Yes	Yes	Yes	Yes
No. of cooling/heating speeds	4 (3 Speeds + Auto)	4 (3 Speeds + Auto)	4 (3 Speeds + Auto)	4 (3 Speeds + Auto)	4 (3 Speeds + Auto)
Twin Flaps	Yes	Yes	No	No	No
Wide angle air swing	120	120	120	120	120
Auto restart after blackout	Yes (by default)	Yes (by default)	Yes (by default)	Yes (by default)	Yes (by default)
Electric heating mode	No	No	Optional	Optional	No
Auto Defrost for outdoor unit	Yes	Yes	Yes	Yes	Yes
Easy to install (special feature)	No	No	Yes	Yes	No
Removable, washable Panel	Yes	Yes	Yes	Yes	No
compressor type	Scroll	Scroll	Rotray	Scroll	Rotary
<b>CONTROLS</b>					
Remote Control	Yes	Yes	Yes	Yes	Yes
<b>AIR PURIFICATION</b>					
Anti bacterial dust filter - washable	Yes	Yes	Yes	Yes	Yes
HEPA filter	Yes	Yes	No	No	No
ION filter	Yes	Yes	No	No	No
<b>ELECTRICAL RATINGS</b>					
Volts/Frequency (Hz)	220-240V/50Hz	220-240V/50Hz	220-240V/50Hz	380V/50Hz/3P	220-240V/50Hz
Fuse Size (Amps)	35	35	35	30	32
Ampere (A) - cooling	17	16,4	12,2	9	12,2
Power input (W) - cooling	3600	3450	2500	4198	2609
Ampere (A) - heating	19,1	16,9	12,4	10	11,9
Power input (W) - heating	4000	3550	2631	5032	2540
Ampere (Heater) OPTIONAL	-	-	9,6	4,6	-
Power input (W) - (Heater) OPTIONAL	-	-	2100	3000	-
LRA (Lock Rotor Amps)	105	90	58	55	42
Power Cord Length (m) - Cabinet to Wall	5,8	5,8	N.A.	N.A.	5,8
<b>DIMENSIONS</b>					
Indoor Unit (WidthxHeightxDepth) (mm)	1220x360x210	1220x360x210	840x220x840	840x320x840	1200x600x230
Indoor Unit Panel (WidthxHeightxDepth) (mm)	-	-	950x40x950	950x40x950	-
Outdoor Unit (WidthxHeightxDepth) (mm)	890x793x414	890x793x414	832x702x380	890x793x414	832x702x380
Weight indoor/panel/outdoor (Kg)	16/88	16/88	35/9/60	46/9/114	36/68



## UNIVERSAL SPARES & ACCESSORIES



# UNIVERSAL SPARES & ACCESSORIES

## TRUNKING

Code 12NC	Description	Dimensions	Standard Q.ty
481281718949	Universal trunking	65x50 - 2mt. Length	12
481281718948	Universal trunking	80x60 - 2mt. Length	8



## TIGHTENING CLAMP

Code 12NC	Description	Dimensions	Standard Q.ty
481281718911	Tightening clamp for 481281718949	65x50	25
481281718933	Tightening clamp for 481281718948	80x60	25



## UPPER CONNECTOR

Code 12NC	Description	Dimensions	Standard Q.ty
481281718912	Connecting two ducts	65x50	25
481281718917	Connecting two ducts	80x60	25



## WALL DUCT

Code 12NC	Description	Dimensions	Standard Q.ty
481281718947	Covering the wall holes	65x50	10
481281718946	Covering the wall holes	80x60	10



## UPPER CONNECTOR SEAL

Code 12NC	Description	Dimensions	Standard Q.ty
481281718913	Made of soft PVC to cover any installation imperfection	65x50	25
481281718918	Made of soft PVC to cover any installation imperfection	80x60	25



## INTERNAL ELBOW

Code 12NC	Description	Dimensions	Standard Q.ty
481281718941	Connecting two ducts at right angle, both horizontal and vertical	65x50	10
481281718943	Connecting two ducts at right angle, both horizontal and vertical	80x60	10



## EXTERNAL ELBOW

Code 12NC	Description	Dimensions	Standard Q.ty
481281718942	Connecting two ducts at right angle, both horizontal and vertical	65x50	10
481281718944	Connecting two ducts at right angle, both horizontal and vertical	80x60	10



## END COVER

Code 12NC	Description	Dimensions	Standard Q.ty
481281718919	Closing the duct in the wall insertion.	65x50	10
481281718921	Closing the duct in the wall insertion.	80x60	10



## FLAT BEND

Code 12NC	Description	Dimensions	Standard Q.ty
481281718934	Connecting two ducts at right angle, one horizontal, the other one vertical	65x50	10
481281718937	Connecting two ducts at right angle, one horizontal, the other one vertical	80x60	10



# UNIVERSAL SPARES & ACCESSORIES

## WALL BEND

Code 12NC	Description	Dimensions	Standard Q.ty
481281718935	Covering the wall hole and the end part of the trunking	65x50	10
481281718938	Covering the wall hole and the end part of the trunking	80x60	10



## T JOINT

Code 12NC	Description	Dimensions	Standard Q.ty
481281718939	Together with a joint reduction it allows the branching of pipes and cables in multiple installations	80x60	8



## JOINT REDUCTION

Code 12NC	Description	Dimensions	Standard Q.ty
481281718927	Connecting ducts of different sizes	125 - 80	10
481281718928	Connecting ducts of different sizes	80 - 65	10



## CUTTER

Code 12NC	Description	Standard Q.ty
481281718929	Special cutter for trunkings	1



## MODULAR AND REVERSIBLE RECESSED HOUSING FRAMES

Code 12NC	Description	Dimensions	Standard Q.ty
481281718945	Modular and reversible recessed housing frames	430x103x68	1



## FLEXIBLE HOSE

Code 12NC	Description	Dimensions	Standard Q.ty
481281718936	Flexible hose	Ø 18/20 - 50mt.	1



## FLARE FITTINGS

Code 12NC	Description	Dimensions (Ø inch)	Standard Q.ty
481281718914	Two pieces flare fittings made of a nut, a compression bush and an already inserted sleeve. No gauge required. Universal application for copper tubes 0.80 and 1 mm thickness Tested and guaranteed at 90 Bar, it can be used with all refrigerant gases.	1/4"	10
481281718916		3/8"	10
481281718915		1/2"	10



## VIBRATION DAMPERS

Code 12NC	Description	Standard Q.ty
481281718923	Vibration dampers in pack of 4 pieces with nuts	1



# UNIVERSAL SPARES & ACCESSORIES

## INVERTING CONNECTORS

Code 12NC	Description	Dimensions (Ø inch)	Standard Q.ty
481281719062	inverting connectors 1/4M x 1/4F used to link refrigeration pipes of the inner unit to the corresponding pipes of the outer unit	1/4"M x 1/4"F	20
481281719063	inverting connectors 3/8M x 3/8F used to link refrigeration pipes of the inner unit to the corresponding pipes of the outer unit	3/8"M x 3/8"F	10
481281719064	inverting connectors 1/2M x 1/2F used to link refrigeration pipes of the inner unit to the corresponding pipes of the outer unit	1/2"M x 1/2"F	10
481281719065	inverting connectors 5/8M x 5/8F used to link refrigeration pipes of the inner unit to the corresponding pipes of the outer unit	5/8"M x 5/8"F	8

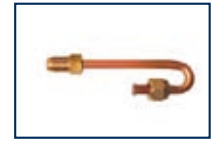

## CONDENSATION OUTLET PIPE

Code 12NC	Description	Type of Packaging	Standard Q.ty
481953020185	shockproof polyethylene tube	in rolls of 50 meters with couplings diam 14mm	1



## WATERWAY MICROPUMP

Code 12NC	Description	Standard Q.ty	With Accessories
481281729274	shockproof polyethylene condensate removal pump with sensor	1	x

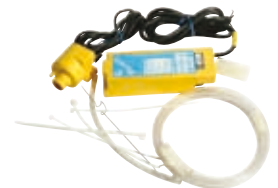

## WURTH INSULATING TAPE

Code 12NC	Description	Dimensions mm W x T	Type of Packaging	Standard Q.ty
481246668725	tape for thermal insulation	50 x 3	roll of 10 mt	1



## OUTDOOR UNIT PROTECTION

Code 12NC	Description	Fits Model	Dimensions mm W x H x D	Standard Q.ty
481281728975	PVC cloth 2,10 mm thick	Green Range: AMB 859-G/AMB 857-G/AMB 867-G Eco Range: AMB 951/AMB 953/AMB 955 Inverter: AMB 868-G/AMB 869-G Slim: AMB 960-G/AMB 961-G/AMB 962-G	770 530 260	1
481281728985	PVC cloth 2,10 mm thick	Green Range: AMB 877-G/AMB 959-G Eco Range: AMB 957/AMB 959 Slim: AMB 963-G/964-G Dual Green: 891-G/892-G	880 620 400	1



# UNIVERSAL SPARES & ACCESSORIES

## SAMSUNG ROTARY COMPRESSOR

## GAS TYPE R407c

Code 12NC	Description	Power BTU/h	Capacity Kcal/h	Watts	Power supply
481281729465	F4A070JW1EB	7200	1,752	2,037	220-240V 50Hz
481281729466	F4B092JW1EG	9400	2,344	2,726	220-240V 50Hz
481281729467	F8D124JU1EF	12400	3,049	3,546	220-240V 50Hz
481281729468	F8B180JV1EH	18200	4,435	5,158	220-240V 50Hz
481281718299	55A250JU1EM	25000	6,099	7,092	220-240V 50Hz



## SAMSUNG ROTARY COMPRESSOR

## GAS TYPE R407c

Code 12NC	Description	Standard Q.ty	With Acces-sories	Accumulator Size	Accumulator Position
481281729465	F4A070JW1EB	1	x	B*	30°
481281729466	F4B092JW1EG	1	x	G*	30°
481281729467	F8D124JU1EF	1	x	F*	30°
481281729468	F8B180JV1EH	1	x	H*	30°
481281718299	55A250JU1EM	1	x	M*	30°

Out Dia (mm) x Height (mm)  
 \*B=41,3 x 190,3  
 \*G=58,0 x 237,0  
 \*F=47,6 x 204,5  
 \*H=77,4 x 262,0  
 \*M= 77,0 x 290,0

## DIMENSIONS mm

Code 12NC	Description	Power BTU/h	A	B	C	D	E	F	G	H	K	L	M	N
481281729465	F4A070JW1EB	7150	216,1	92,0	220,0	35,0	19,0	41,3	8,15	9,64	29,7	117,6	13,0	75,0
481281729466	F4B092JW1EG	9300	233,4	95,0	276,0	35,0	20,0	58,0	8,15	12,85	39,0	117,6	13,0	75,0
481281729467	F8D124JU1EF	12100	243,7	100,8	239,3	35,0	20,0	47,6	8,15	12,85	34,6	127,4	20,0	88,0
481281729468	F8B180JV1EH	17600	267,1	114,5	311,0	35,0	20,0	77,4	9,7	12,85	51,0	127,4	20,0	88,0
481281718299	F5A250JU1EM	24200	306,1	124,8	348,6	35,0	20,0	77,0	9,7	16,03	58,6	146,0	20,0	88,0

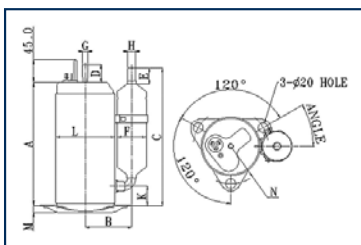

481281729465  
 481281729466  
 481281729467  
 481281729468  
 481281718299

## CONVERSION TABLE

1 Kcal/h	3,9 BTU/h	1,163 W
1 BTU/h	0,25 Kcal/h	0,293 W
1 W	0,86 Kcal/h	3,4 BTU/h

Example:

$$6,924 \text{ BTU/h} \times 0,25 = 1,731 \text{ Kcal/h}$$

$$6,924 \text{ BTU/h} \times 0,293 = 2,028 \text{ W}$$

# UNIVERSAL SPARES & ACCESSORIES

## SAMSUNG ROTARY COMPRESSOR

## GAS TYPE R22

Code 12NC	Description	Power BTU/h	Capacity Kcal/h	Watts	Power supply
481281728584	44A056JU1EB	5600	1,401	1,629	220-240V 50Hz
481281728585	44A070JUAEB	7200	1,802	2,095	220-240V 50Hz
481281728586	44B092JXAEL	9400	2,369	2,755	220-240V 50Hz
481281728587	44D124JXAEL	12400	3,138	3,649	220-240V 50Hz
481281728588	48B180JUBEH	18200	4,486	5,217	220-240V 50Hz
481281728879	55A250JUAEM	25000	6,351	7,385	220-240V 50Hz



## SAMSUNG ROTARY COMPRESSOR

## GAS TYPE R22

Code 12NC	Description	Standard Q.ty	With Acces- sories	Accumulator Size	Accumulator Position
481281728584	44A056JU1EB	1	x	B*	30°
481281728585	44A070JW1EC	1	x	C*	30°
481281728586	44B092JW1EL	1	x	L*	30°
481281728587	48A124JV1EL	1	x	L*	30°
481281728588	48B180JV1EH	1	x	H*	30°
481281728879	55A250JU1EM	1	x	M*	30°

Out Dia (mm) x Height (mm)

\*B=41,3 x 190,3

\*C=41,3 x 222,0

\*L=58,0 x 237,0

\*H=77,4 x 262,0

\*M= 77,0 x 290,0

## DIMENSIONS mm

Code 12NC	Description	Power BTU/h	A	B	C	D	E	F	G	H	K
481281728584	44A056JU1EB	5600	209,1	101,08	220,0	35,0	19,0	29,0	8,15	9,64	29,7
481281728585	44A070JW1EC	7150	216,1	92,0	220,0	35,0	19,0	41,3	8,15	9,64	29,7
481281728586	44B092JW1EL	9400	233,4	95,0	276,0	35,0	20,0	58,0	8,15	12,85	39,0
481281728587	48A124JV1EL	12400	243,7	98,0	271,6	35,0	20,0	58,0	8,15	12,85	34,6
481281728588	48B180JV1EH	18100	267,1	114,5	311,0	35,0	20,0	77,4	9,70	12,85	51,0
481281728879	55A250JU1EM	25400	306,1	123,7	348,6	35,0	20,0	77,0	9,70	16,03	58,6

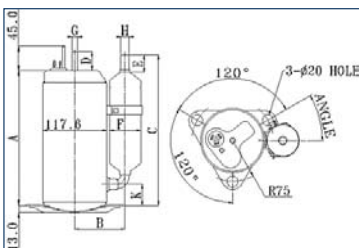

481281728584

481281728585

481281728886

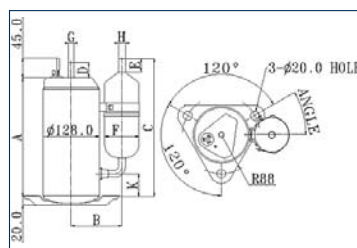

481281728887

481281728588

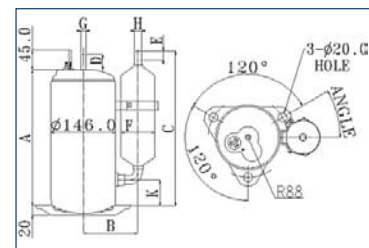

481281728879

## Rotary compressors accessory kit

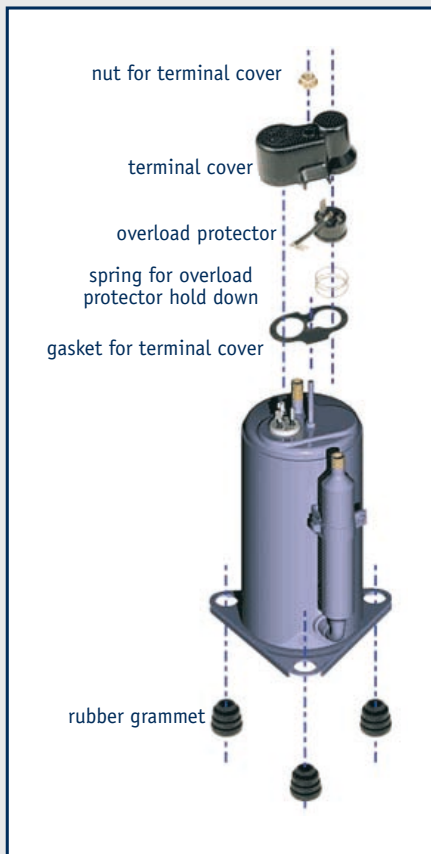

### Internal Type

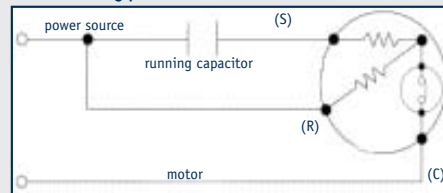

### External Type

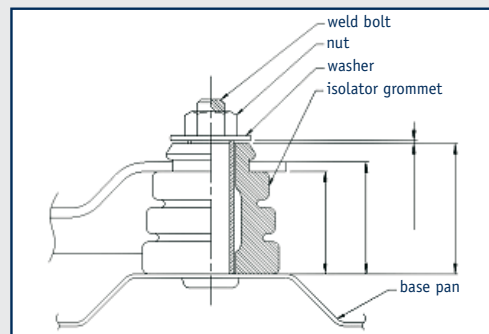
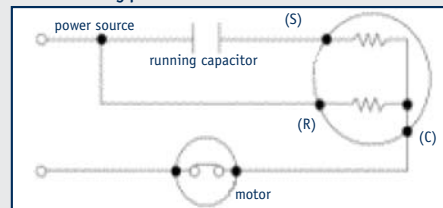

# UNIVERSAL SPARES & ACCESSORIES

## PREINSULATED COPPER TUBES 8 mt. range

Code 12NC	Thickness mm	Diameter Inch	Type of Packaging	Standard Q.ty	Gas Type
481281718282	1,00	1/4" (mm 6,35)	rolls of 8 meters	1	R22/R407c/R410a
481281718284	1,00	3/8" (mm 9,53)	rolls of 8 meters	1	R22/R407c/R410a
481281718283	1,00	1/2" (mm 12,70)	rolls of 8 meters	1	R22/R407c/R410a
481281718286	0,8	1/4" (mm 6,35)	rolls of 8 meters	1	R22/R407c/R410a
481281718287	0,8	3/8" (mm 9,53)	rolls of 8 meters	1	R22/R407c/R410a
481281718288	0,8	1/2" (mm 12,70)	rolls of 8 meters	1	R22/R407c/R410a
481281718285	1,00	5/8" (mm 15,88)	rolls of 8 meters	1	R22/R407c/R410a
481281718374	1,00	3/4" (mm 19,05)	rolls of 8 meters	1	R22/R407c/R410a



## PREINSULATED COPPER TUBES 25 mt. range

Code 12NC	Thickness mm	Diameter Inch	Type of Packaging	Standard Q.ty	Gas Type
481281718271	1,00	1/4" (mm 6,35)	rolls of 25 meters	1	R22/R407c/R410a
481281718273	1,00	3/8" (mm 9,53)	rolls of 25 meters	1	R22/R407c/R410a
481281718272	1,00	1/2" (mm 12,70)	rolls of 25 meters	1	R22/R407c/R410a
481281718275	0,8	1/4" (mm 6,35)	rolls of 25 meters	1	R22/R407c/R410a
481281718276	0,8	3/8" (mm 9,53)	rolls of 25 meters	1	R22/R407c/R410a
481281718277	0,8	1/2" (mm 12,70)	rolls of 25 meters	1	R22/R407c/R410a
481281718274	1,00	5/8" (mm 15,88)	rolls of 25 meters	1	R22/R407c/R410a
481281718373	1,00	3/4" (mm 19,05)	rolls of 25 meters	1	R22/R407c/R410a



## PREINSULATED COPPER TUBES 50 mt. range

Code 12NC	Thickness mm	Diameter Inch	Type of Packaging	Standard Q.ty	Gas Type
481281728626	1,00	1/4" (mm 6,35)	rolls of 50 meters	1	R22/R407c/R410a
481281728628	1,00	3/8" (mm 9,53)	rolls of 50 meters	1	R22/R407c/R410a
481281728627	1,00	1/2" (mm 12,70)	rolls of 50 meters	1	R22/R407c/R410a
481281729305	0,8	1/4" (mm 6,35)	rolls of 50 meters	1	R22/R407c/R410a
481281729306	0,8	3/8" (mm 9,53)	rolls of 50 meters	1	R22/R407c/R410a
481281729307	0,8	1/2" (mm 12,70)	rolls of 50 meters	1	R22/R407c/R410a
481281728771	1,00	5/8" (mm 15,88)	rolls of 50 meters	1	R22/R407c/R410a
481281718372	1,00	3/4" (mm 19,05)	rolls of 50 meters	1	R22/R407c/R410a





# UNIVERSAL SPARES & ACCESSORIES

## PREINSULATED TWIN COPPER TUBES 20 mt. range

Code 12NC	Thickness mm	Diameter Inch	Standard Q.ty	Gas Type	Total diameter mm
481281718289	0,8 x 0,8	1/4" (mm 6,35) - 3/8" (mm 9,53)	1	R22/R407c/R410a	approx. 36
481281718291	0,8 x 0,8	1/4" (mm 6,35) - 1/2" (mm 12,7)	1	R22/R407c/R410a	approx. 39
481281718292	0,8 x 1	1/4" (mm 6,35) - 5/8" (mm 15,88)	1	R22/R407c/R410a	approx. 42,30
481281718293	0,8 x 0,8	3/8" (mm 9,53) - 1/2" (mm 12,7)	1	R22/R407c/R410a	approx. 42,30
481281718294	0,8 x 1	3/8" (mm 9,53) - 5/8" (mm 15,88)	1	R22/R407c/R410a	approx. 45,50
481281718295	0,8 x 1	3/8" (mm 9,53) - 3/4" (mm 19,05)	1	R22/R407c/R410a	approx. 48,60
481281718296	0,8 x 1	1/2" (mm 12,70) - 3/4" (mm 19,05)	1	R22/R407c/R410a	approx. 51,80



## GAS

Code 12NC	Gas Type	Description	Capacity in Litres	Net content in Kg	Standard Q.ty
4812 817 18737	R22	1 litre disposable bottles	1	approx. 1Kg	6
4812 817 28248	R22	6 litres returnable bottles 47 bar	6	6,00	1
4812 817 28198	R22	12,1 litres returnable bottles	12,1	12,00	1
4812 817 18736	R407c	1 litre disposable bottles	1	approx. 1Kg	6
4812 817 29449	R407c	6 litres returnable bottles 47 bar	6	5,50	1
4812 817 29302	R407c	12,1 litres returnable bottles	12,1	11,50	1
4812 817 18318	R407c	13,6 litres disposable bottles EN12205	13,6	11,30	1
4812 817 18735	R410a	1 litre disposable bottles	1	approx. 1Kg	6
4812 817 18315	R410	6 litres returnable bottles 47 bar	6	4,50	1
4812 817 18316	R410	12,3 litres returnable bottles	12,3	9,50	1



## CERTIFIED ELECTRICAL CABLES

Code 12NC	Thickness mm	Type of Packaging	N° of Poles	Standard Q.ty
481281728429	1,5	in rolls of 100 meters	3	1
481281728431	1,5	in rolls of 100 meters	5	1
481281729735	2,5	in rolls of 100 meters	3	1
481281718123	1,5	in rolls of 100 meters	7	1



# UNIVERSAL SPARES & ACCESSORIES

## AIR CONDITIONERS SUPPORT

Code 12NC	Max Load Weight in Kg	Description	Standard Q.ty	With Installation Kit
481281728442	95	quick assembly	1	x
481281728464	95	pre assembled slv 380	1	x



## AIR CONDITIONERS SUPPORT

Code 12NC	Max Load Weight in Kg	Description	Standard Q.ty	With screws
481281718205	80	1 piece	6	x
481281718206	100	1 piece	6	x



## FLOOR SUPPORT

Code 12NC	Max Weight in Kg	Description	Standard Q.ty	With Installation Kit
481281728717	180	PVC floor support 35 cm length	2	x
481281728718	180	PVC floor support 45 cm length	2	x



## CATECHIN FILTER

Code 12NC	Fits Model	Dimensions mm L x W x H	Standard Q.ty
481248128175	single Green: AMB 859-G/AMB 857-G/ AMB 867-G/AMB 877-G/AMB 887-G dual Green: AMB 891-G/AMB 892-G	245 60 5	1



## ACTIVE CARBON FILTER

Code 12NC	Fits Model	Dimensions mm L x W x H	Standard Q.ty
481248128172	single Green: AMB 859-G/AMB 857-G/ AMB 867-G/AMB 877-G/AMB 887-G dual Green: AMB 891-G/AMB 892-G inverter: AMB 868	321 77 7	1



Fits also Classic range

## HEPA FILTER + ELECTROSTATIC FILTER

Code 12NC	Fits Model	Dimensions mm L x W x H	Standard Q.ty
481248128169	AMB 868	249 35 7	1



# UNIVERSAL SPARES & ACCESSORIES

## CHARGE STATIONS

Code 12NC	Description
481281718801	<b>Charge station STE-134/600-80V</b> Loading Station for R134a & R600a, with scale up to 2000gr. Two stage vacuum pump STB-22. Vacuum gauge 1000-0mbar
481239588414	<b>Charge station -12900-</b> Universal loading Station, bourdon type gauges with interchangeable refrigerant scales for R12, R22, R502, R134a, R404a, R407c, R507, electronic charging scale up to 100kg Set of 900 mm. charging hoses, vacuum pump RL2, vacuum gauge 80mm. diameter
481281718803	<b>Charge station STE-SV45-ADS</b> Universal loading Station, four ways manifold, vacuum gauge 1000-0 mbar, non programmable electronic charging scale up to 100kg. Set of 1500mm. charging hoses, quick couplings, two ways vacuum pump STB-22



481281718801



481239588414



481281718803

## TECHNICIAN KITS

Code 12NC	Description
481281718797	<b>TECHNICIAN Kit STE-KIT-80-410-E6</b> Kit in high capacity with wheels. Double stage vacuum pump for R410a with solenoid valve and gauge. Two ways manifold for R410a. Two ways manifold for E134a, R404a, R407c, R22. 1500mm charging hoses set: 1/4 H SAE x 1/4 SAE. 1500mm charging hoses set: 1/4 H SAE x 5/16 SAE for R410a. Electronic scale mod TIF 9010. Adapter 1/4 SAE x 5/16 SAE
481281718798	<b>TECHNICIAN Kit STK-2004-80410</b> kit of components for stations. Electronic scale Mod. 8025-02-900. Disposable cartridges service valve with platform. Adapter 1/4 SAE x 5/16 SAE. Four ways manifold for R410a. 1500 mm charging hoses set 1/4 H SAE x 5/16 SAE for R410a
481281718799	<b>TECHNICIAN Kit STK-2004-80E6</b> kit of components for stations. Electronic scale Mod. 8025-02-900. Disposable cartridges service valve with platform. Adapter 1/4 SAE x 1/4 SAE. Four ways manifold for R134a, R404a, R407c, R22. 1500 mm charging hoses set 1/4 H SAE x 1/4 SAE.
481281718802	<b>VACUUM Pump FOR R410A STB-2410-DS</b> Two stage vacuum pump 50 lt./min., 220V. 50/60Hz. Equipped with electronic check valve, vacuum gauge 80mm. And scale



481281718797



481281718798



481281718799



481281718802

## REFRIGERANT MAINTENANCE

Code 12NC	Description
481281718804	digital scale <b>TIF9010A</b>
481281718805	leak detector <b>TIF-XL-1A</b> , detects all ahalogenated refrigerants
481281718806	Cartridge <b>SERVICE VALVES PLATFORM 1/4"</b> Platform H1/4" SAE x M 1/4" SAE (for R134a, R22, R407c disposable cartridges)
481281718807	Cartridge <b>SERVICE VALVES-PLATFORM 5/16"</b> Platform H5/16" SAE x M 1/4" SAE (for R410a disposable cartridges)
481281718808	Digital vacuum gauge <b>VG-64</b>
481281718909	Coupling high pressure
481281718809	Coupling low pressure



481281718804



481281718805



481281718806



481281718807



481281718808



481281718909



481281718809

# UNIVERSAL SPARES & ACCESSORIES

## RECOVERY STATIONS

Code 12NC	Description	Stages	Weight	Vacuum	Flow
481281719141	Recovery station-Minimax-Mini oil-less recovery station suitable for all gases including R410a	2	3,8kg	15 Mic.	35 L/min
481239588426	Recovery station -Plus 12- Compact oil-less recovery station suitable for all gases including R410a	2	5,65kg	15 Mic.	35 L/min
481239588377	Recovery Station -Plus 8- Oil-less recovery station suitable for all gases including R410a	2	11,8kg	15 Mic.	35 L/min



481281719141



481239588426



481239588377

## VACUUM PUMPS

Code 12NC	Description	Stages	Weight	Vacuum	Flow
481239598149	Vacuum pump -RL-2-	2	3,8kg	15 Mic.	35 L/min
481239588371	Vacuum pump -RL-4-	2	5,65kg	15 Mic.	65 L/min
481239588377	Vacuum pump -RL-8-	2	11,8kg	15 Mic.	150 L/min
481281718811	Vacuum Pump ST-12-SS 40 LT.	2	7kg	60 Mic.	40 L/min
481281718812	Vacuum Pump ST-62-SS 105 LT.	2	15kg	30 Mic.	105 L/min
481281718813	Vacuum Pump ST-92-SS 150 LT.	2	15kg	30 Mic.	150 L/min
481281718814	Vacuum Pump STB-TST-12 37 LT.	2	10,5kg	50 Mic.	37 L/min
481281718815	Vacuum PUMP STB-TST-22 70LT.	2	13,5kg	50 Mic.	70 L/min
481281718816	Vacuum Pump STB-TST-92 184LT.	2	23,5kg	50 Mic.	184 L/min



481239598149  
481239588371  
481239588377



481281718811  
481281718812  
481281718813



481281718814  
481281718815  
481281718816



## Refrigerant Gas

- R410a came to Europe in 2001 and is now recognized as a very efficient and environmental friendly gas.
- R410a is non toxic and not inflammable, which makes it friendly to handle.
- R410a has chemical characteristics similar to those of R22, this makes it easy for use for installation and service.

	ODP (CFC=1,0)	GWP (CO2=1,2)	COMPOSITION
R22	0,055	1700	HFC 32/HFC 125/HFC134a=23/25/52wt%
R407c	0	1500	HFC 32/HFC 125/=50/50wt%
R410a	0	1370	HFC 32/HFC 125/=50/50wt%

Code 12NC	Language Cluster	Standard Q.ty	Content (ml)
481281718111	F - NL	6	400
481281718112	UK - D	6	400
481281718113	I - F	6	400
481281718114	CZ - SL - RO - H	6	400
481281718141	NOR - FIN - S - DK	6	400

## Wpro Sanitizer

Suitable for air conditioning systems, refrigerators and soft drink dispensers. Eliminates unpleasant odours and sanitizes your appliances.







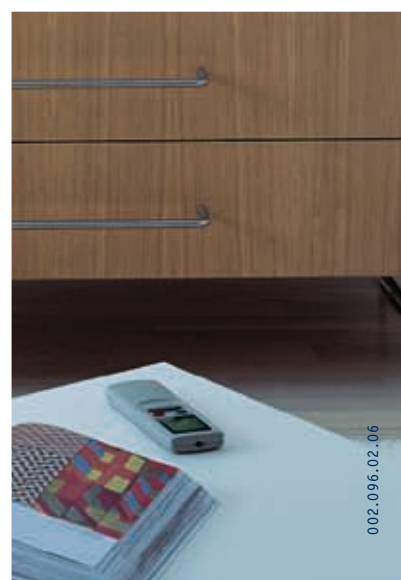

## Whirlpool Europe srl

Viale Guido Borghi, 27  
21025 Comerio (VA) Italy  
[www.whirlpool.com](http://www.whirlpool.com)

Ihren Stützpunkthändler für Whirlpool Klimageräte erreichen Sie im

### **EVC Mannheim**

Hans-Thoma-Strasse 15 68163 Mannheim

Free Call:

Tel.: 0800 41 75 700  
Fax: 0800 41 26 440

Oder besuchen Sie unsere Internetseite  
[www.evc-mannheim.de](http://www.evc-mannheim.de)



Whirlpool is a registered trademark of Whirlpool U.S.A.  
Specifications subject to change without prior notice